

Centrometal

HEATING TECHNIQUE

Centrometal d.o.o. - Glavna 12, 40306 Macinec, Croatia, tel: +385 40 372 600, fax: +385 40 372 611

ENG

Technical instructions



**Technical instructions for boiler control
CUPREG-Touch / 100°C (for installation and use):**

- oil/gas boiler control
- heating system control and DHW preparation control
- max. operating temperature 100°C



**THE FIRST START-UP MUST BE DONE BY AUTHORIZED PERSON,
OTHERWISE PRODUCT WARRANTY IS NOT VALID.**

CUPREG-Touch / 100°C



These instructions are an integral part of this product. All rights reserved. Reproduction of content of this document and transfer to third parties is not allowed without written approval from manufacturer.

Make sure the instructions are always with the device, even if its sale / transfer of another owner to the user or staff authorized for maintenance or repairs to consult.



READ THESE INSTRUCTIONS CAREFULLY BEFORE INSTALLING THE BOILER TO HEATING SYSTEM.



Boiler must not be used by children or disabled persons (either physically or mentally), as well as by person without knowledge or experience, unless they are under control or trained by a person responsible for their safety. Children must be supervised in the vicinity of the product.



Boiler must not operate in flammable and explosive environment.



Before any work on the boiler, electric energy must be switched off.



Please note that the installation, startup and maintenance can only be performed by a qualified heating contractor or service organization. Any work on electrical and fuel carrying components must be done by a qualified service technician.

GENERAL DESCRIPTION

Digital boiler controller CUPREG-Touch / 100°C - (max. boiler operating temperature 100°C) is intended for installation on hot water boilers EKO-CUP S3, EKO-CUP SU3, EKO-CUP V3, EKO-CUP SV3 2500, for controlling the operation of a boiler with a single-stage, two-stage or modulation burner.

Boiler controller components CUPREG-Touch used by a user:



Touchscreen with
bicolour LED

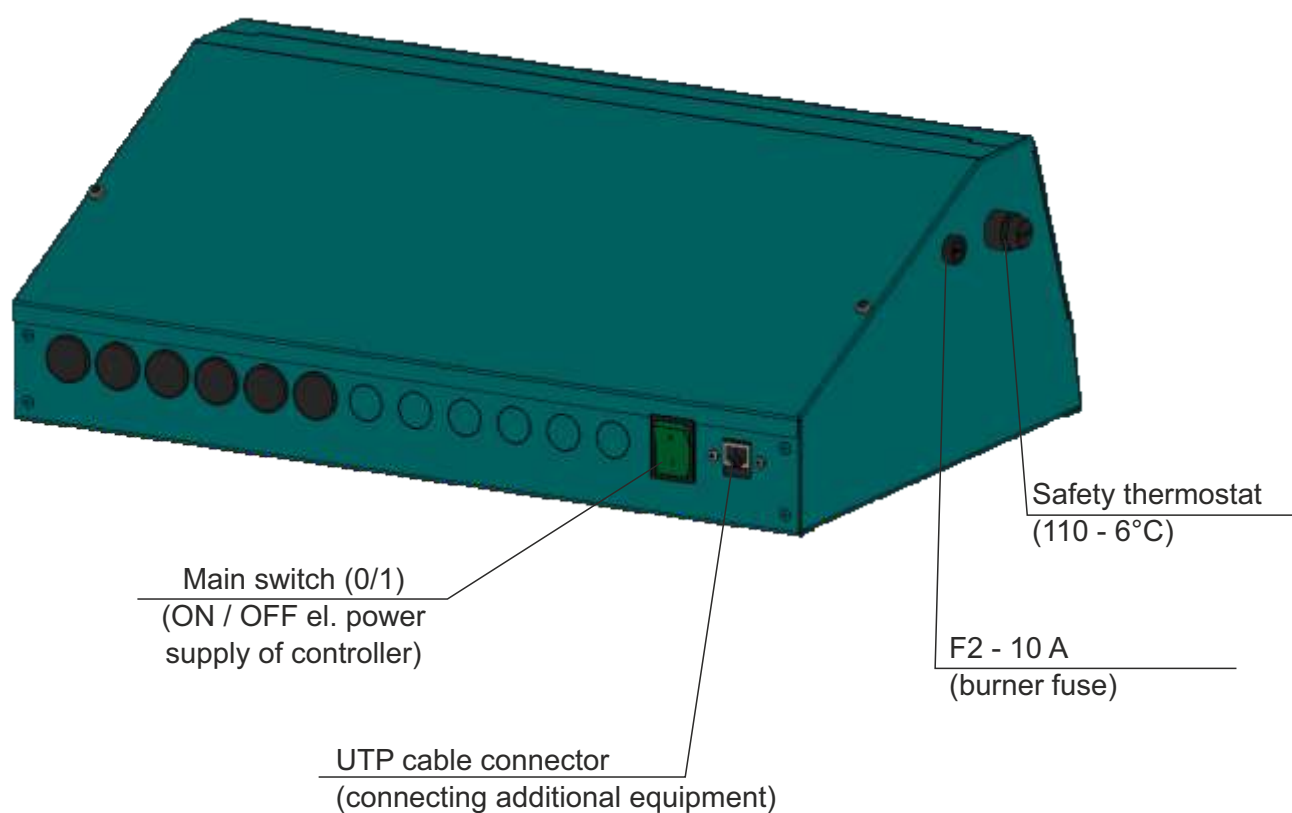

Main switch (0/1)
(ON / OFF el. power
supply of controller)

UTP cable connector
(connecting additional equipment)

Safety thermostat
(110 - 6°C)

F2 - 10 A
(burner fuse)

DELIVERY STATUS

Temperature sensors that come with boiler controller:

- 1 x boiler sensor (PT 1000)-PVC, L=3000 mm, factory installed
- 1 x flue gas sensor (PT 1000), L=1500 mm) (including sensor sleeve), in a nylon bag
- 1 x outdoor sensor (PT 1000), in its own cardboard box
- 6 x sensors (PT 1000)-PVC , L=1000 mm (included 3 x (PVC holder, PVC shoelace, paste for mounting sensors on the pipe)), in a nylon bag

Safety thermostat (STB) (factory installed on a controller):

- STB thermostat switch-off temperature 110-6 °C
- capillary length STB thermostat L=3000 mm

ADDITIONAL EQUIPMENT

CAL
alarm box
(light/speaker)



Cm wifi-box
(Internet
supervision)



CM-GSM alarm
module for
mobile network



CM2K module
for controller
2+ heating circuits



Fuel oil level sensor
in the tank



CONTROLLER INSTALATION

EKO-CUP S3, EKO-CUP SU3

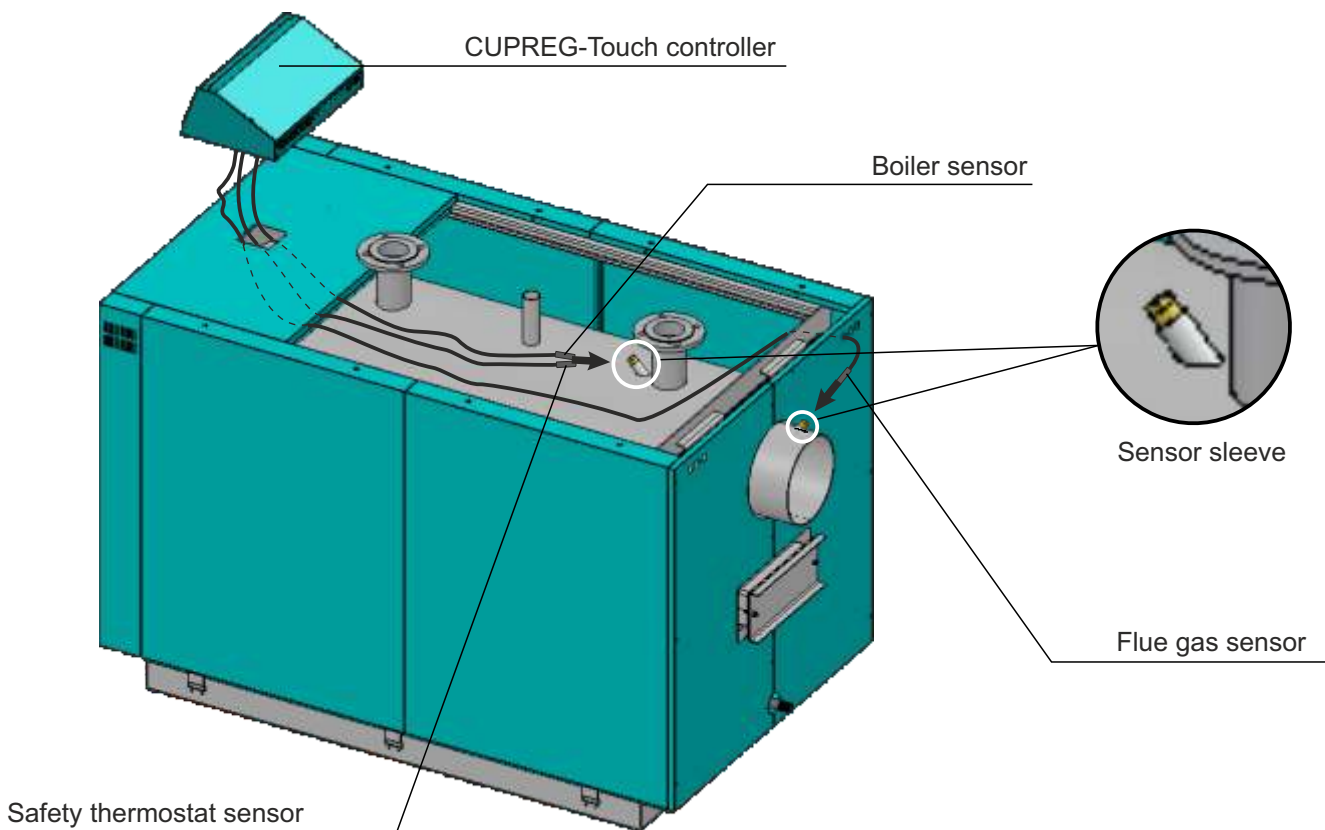

Flue gas sensor installation procedure

- fasten the controller with metal screws 3.9 x 9.5 (2 pcs)



- first unscrew the plug from the socket (1)
- put on the sensor sleeve (2)
- put on the flue gas sensor (3)

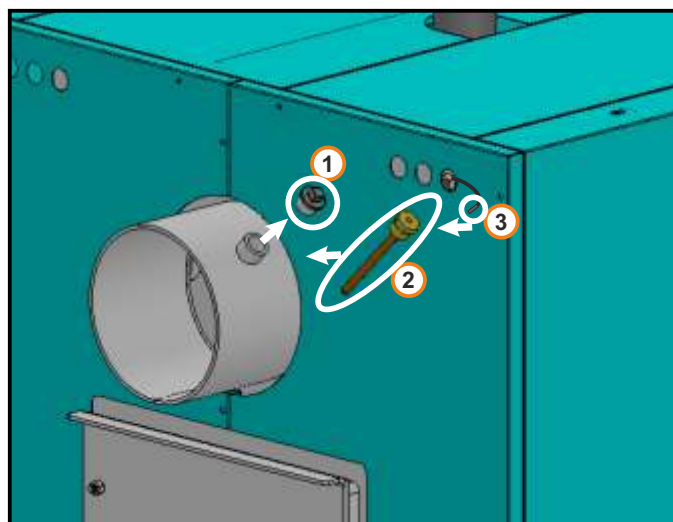
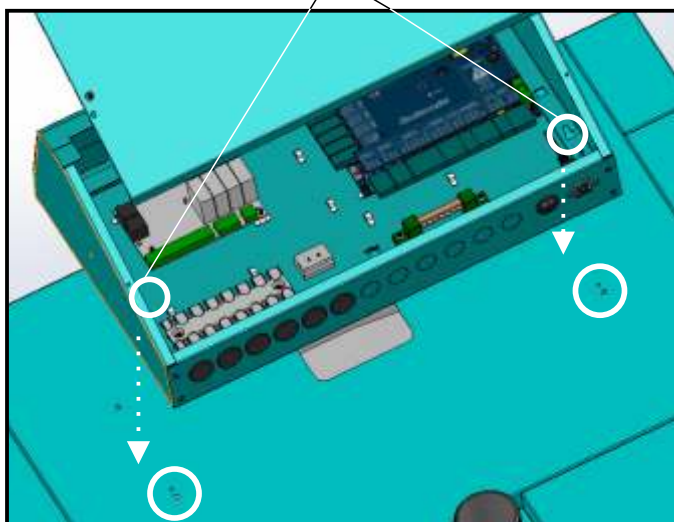

Controller instalation

EKO-CUP V3, EKO-CUP SV3 2500

- controller can be placed on the left or right side of the boiler.

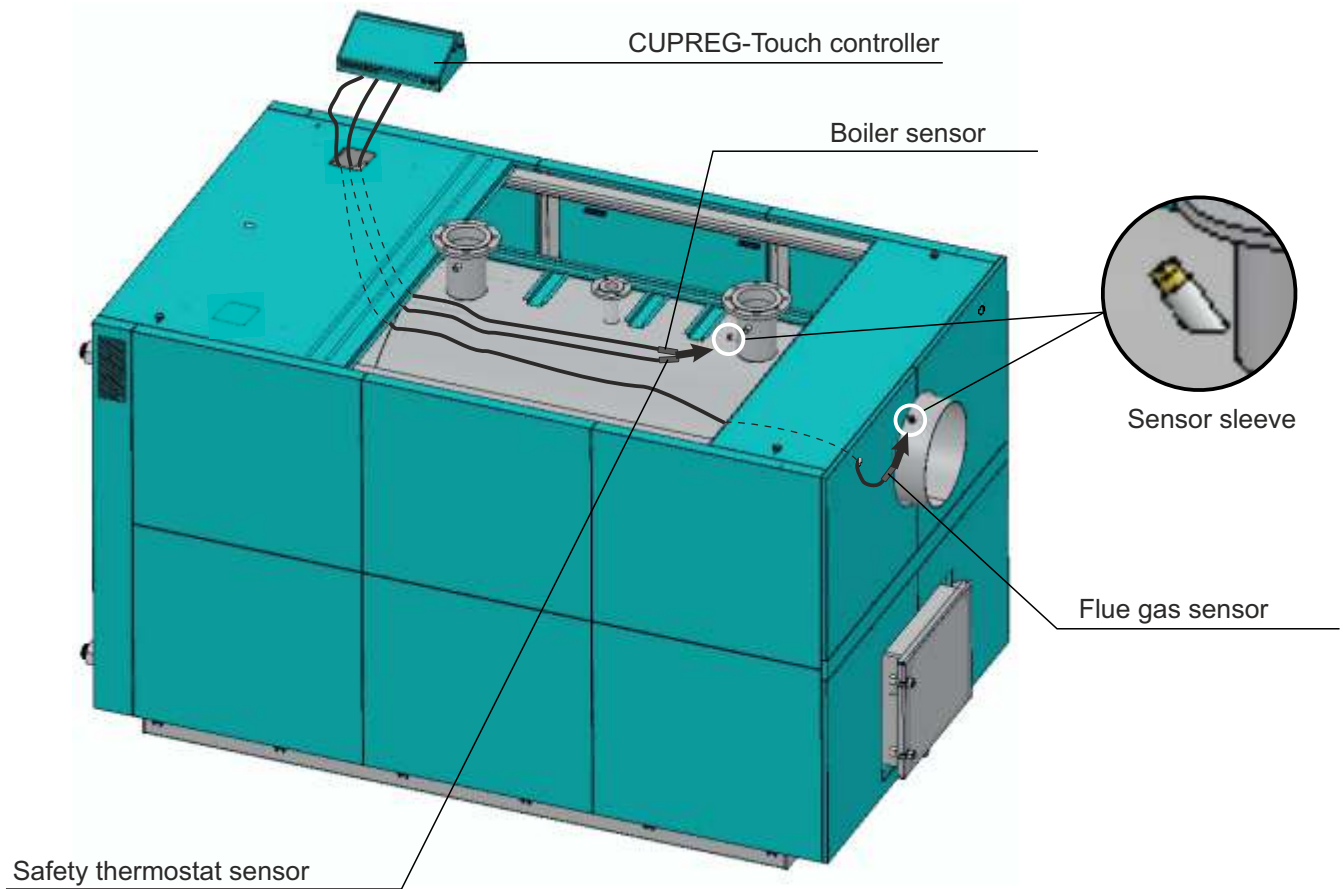

Flue gas sensor installation procedure

- fasten the controller with metal screws
3,9 x 9,5 (2 pcs)



- first unscrew the plug from the socket (1)
- put on the sensor sleeve (2)
- put on the flue gas sensor (3)

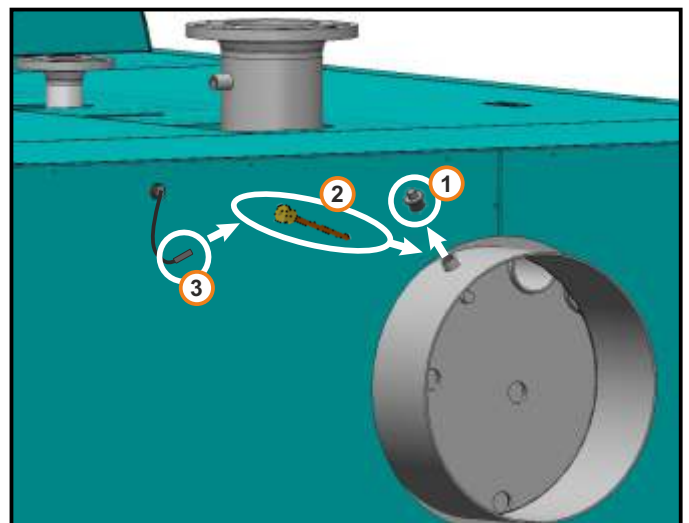
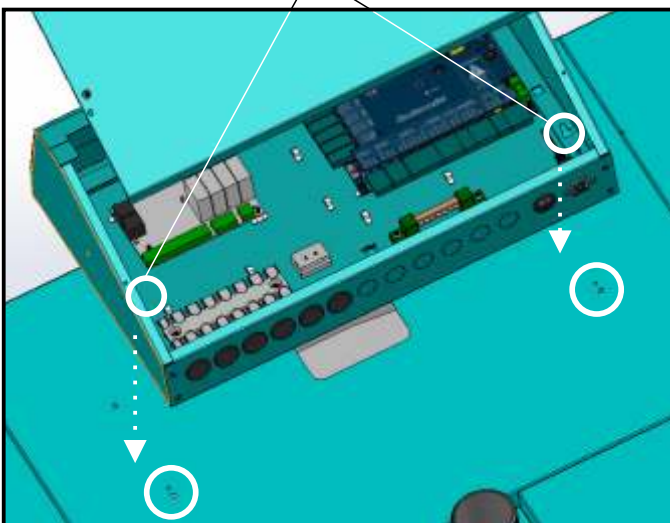

ELECTRICAL CONNECTION



All electrical works must be performed by a certified professional in accordance with valid national and European standards. A device for switching of all power supply poles must be installed in electrical installation in accordance with the national regulations on electrical installations.

When doing el. installation, performed by an authorized electrician, it is necessary to remove the boiler controller cover (1) in which there are connectors and in-line terminals for boiler controller power supply, connection of burners, pumps and sensors. The cables must be routed through the rubber place for them (2) on the back of the boiler controller.

Example: EKO-CUP S3, EKO-CUP SU3 (also valid for EKO-CUP V3, EKO-CUP SV3 2500)

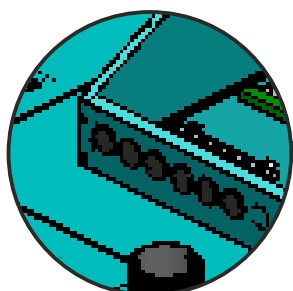

Rubber place for cable

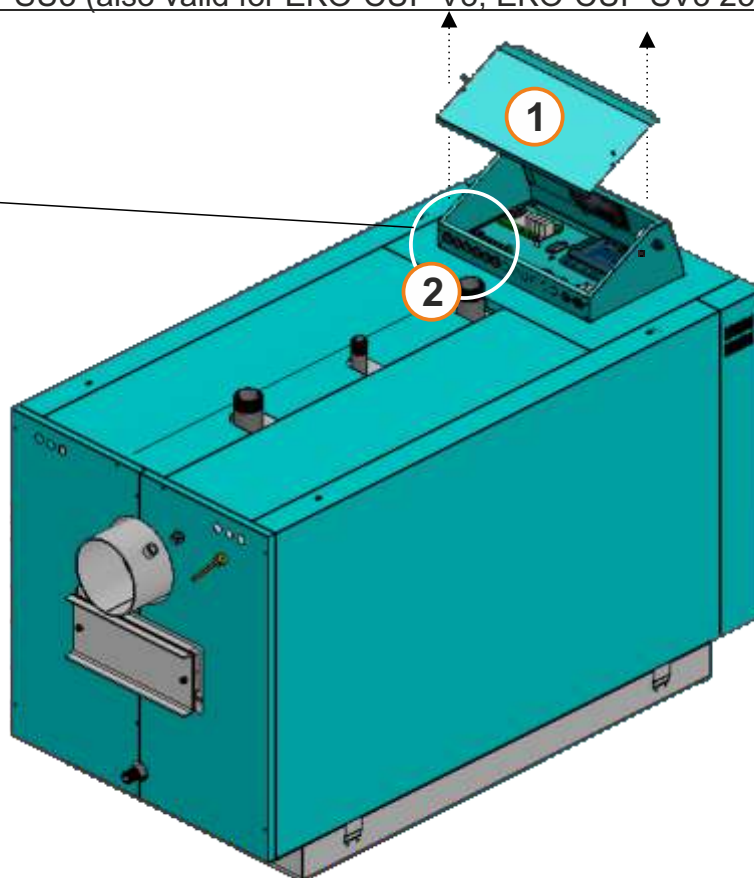

INSTALLATION OF SENSOR ON THE PIPE (flow and return line)

Installation instructions sensor on the pipe (flow and return line)

1. Tightly clean the pipe
2. Smear the place for the contact with silicone paste (A)
3. Fasten the sensor with fasten ribbon

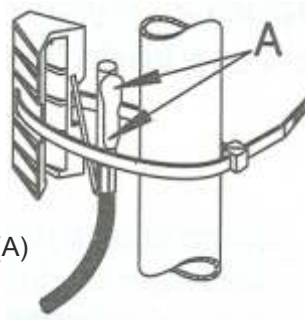

SWITCHING ON / DISPLAY

After switching the main switch on, the language selection and software version will appear on the screen. You can choose between different languages. To select the preferred language press a flag on display.



If the option "LANGUAGE SELECTION" is "OFF" in the main menu under the name "DISPLAY", the initial message will appear on the screen (see the picture below) and it will stay as long as is set in the submenu "INITIAL MESSAGE TIME" or until you press the "OK" button.



Touchscreen must not be pressed while switching the main switch on, otherwise the controller will show a firmware update mode, which is used by an authorized person only. If this happens, please switch the main switch off and switch it back on without pressing the touchscreen.

THE MAIN MENU

The main menu is used to select a preferred submenu. To enter into a certain menu press an icon on the screen. To switch between the "Main menu" and "Boiler working display" press the "VIEW SELECTION" button. To display drop-down menu (if it is enabled) use the "SHORTCUTS" button.

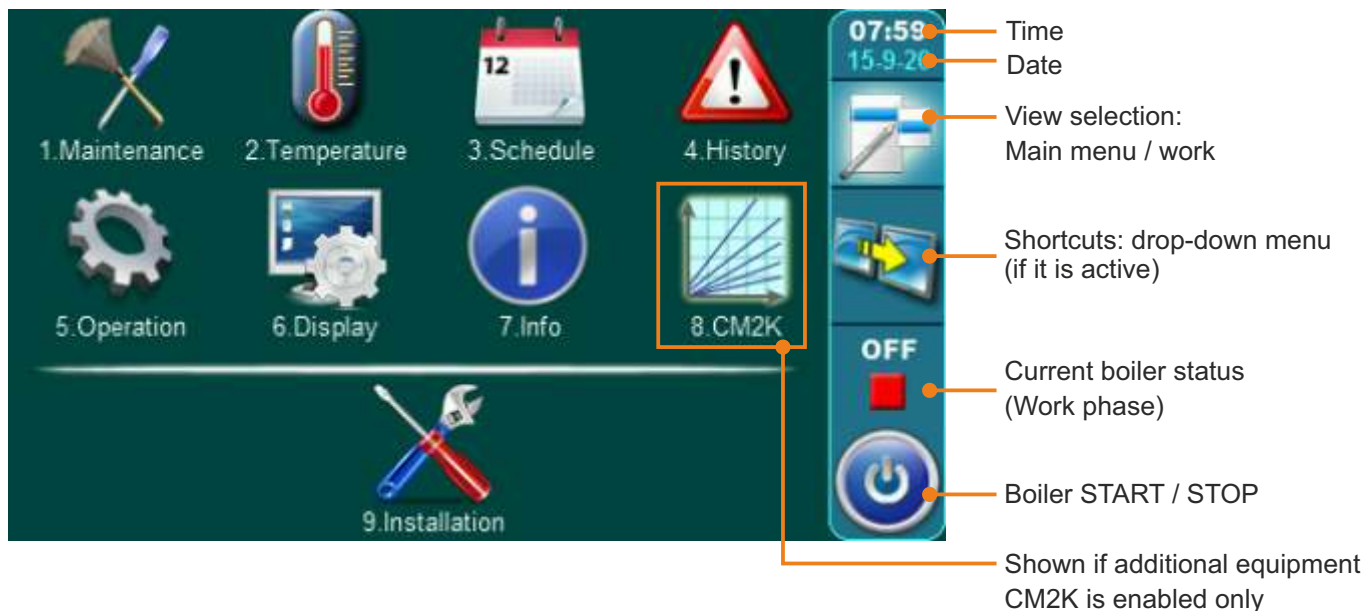

SYMBOLS



Button "ON / OFF"
options: on / off boiler operation"



Button "VIEW SELECTION"
options: main menu / home screen



Button "SHORTCUTS": Drop-down menu (if it is active)"



Button "ENTER"

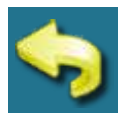

Button "BACK"



Button "PREVIOUS SCREEN"



Button "NEXT SCREEN"

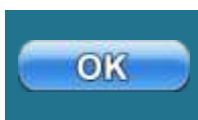

Button "OK"

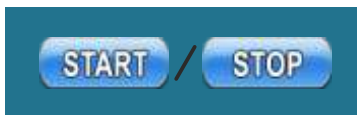

Button "START"/"STOP"

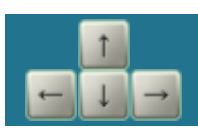

Navigation buttons:
"LEFT", "RIGHT", "UP", "DOWN"



Button "DELETE"



Button "FACTORY SETTINGS"



Button "INFORMATION"



Button "COPY"



Button "PASTE"

SYMBOLS

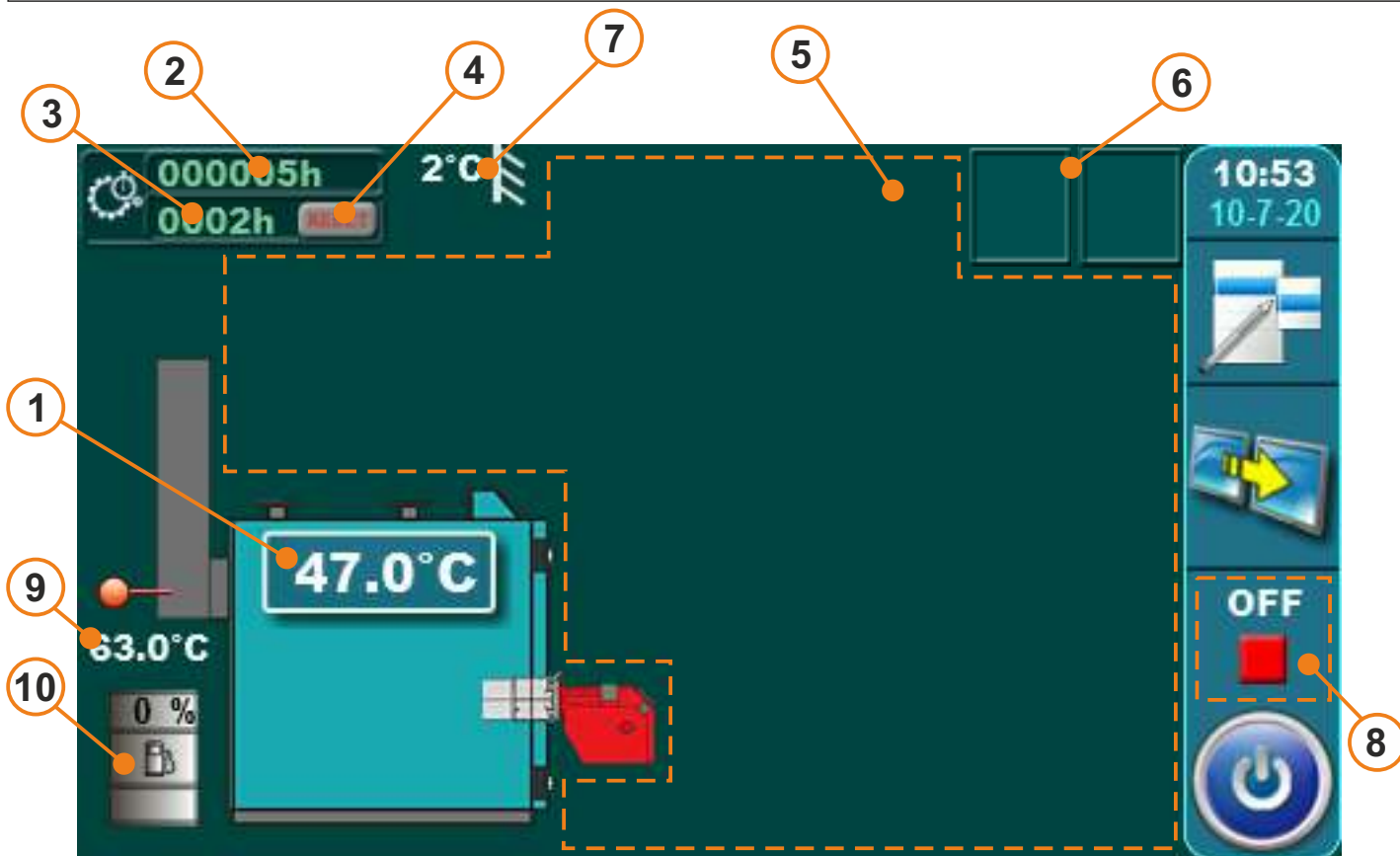

Symbols:

- 1 - Boiler temperature
- 2 - Burner working hours counter (without the possibility of reset)
- 3 - Burner working hours counter (with the possibility of reset)
- 4 - Burner working hours reset button
- 5 - Dynamic configuration view (view depends on set configuration)
- 6 - Heating mode / Freeze guard /Additional equipment view * (cascade, wifi...)
- 7 - Outside temperature
- 8 - Boiler operation phase
- 9 - Flue gas temperature
- 10 - Fuel oil level sensor in the tank (additional equipment) *

* - additional equipment on screen only if additional equipment is installed and enabled (fuel level sensor)



Pump (no demand to work)



Pump has demand to work (when there is demand to work, given by a customer, yellow rectangle appears inside the pump symbol, but pump doesn't work if all the conditions are not fulfilled; i.e. too low temperature in the boiler, otherwise it works). It rotates while working, it doesn't rotate while not working.



Room thermostat

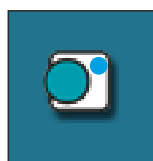

Next to the room thermostat symbol bright blue circle (the room thermostat has requested for operating the pump, the pump does not work if you have not met all the conditions for its operation, for example. low temp. in the boiler, otherwise normally works)



Room corrector symbol show current measured room temperature (20.0°C), set room temperature in controller + set room corrector correction (20.0+5.0°C).

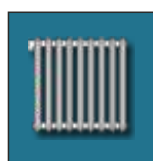

Heating circuit



Domestic hot water tank with current temperature



External control – there is a demand



External control – there is no demand

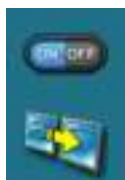

View button / Drop-down menu (all existing elements of automatic / remote boiler start are enabled)



Cascade



Alternative boiler: Manual OFF



Alternative boiler: Manual ON



Alternative boiler: AUTO START



Alternative boiler: ON

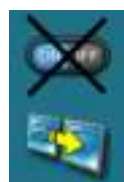

View button / Drop-down menu (some of existing elements of automatic / remote boiler start are enabled)



All elements of automatic / remote boiler start are disabled (ON/OFF button is crossed in red)

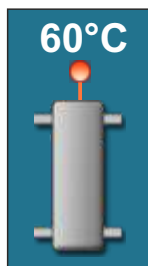

Hydraulic crossover with the current temperature (there are configuration without temp. sensor)

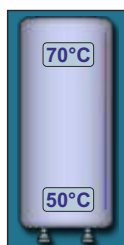

Accumulation tank with current temperature at top of the tank and at the bottom of the tank.



Heating (working mode)



Heating + DHW (working mode)



DHW (working mode)



Cm WiFi-box - not connected



Cm WiFi-box - connected



Alternative boiler: OFF



Alternative boiler: FREEZE ON



The information, only appears in configurations with an alternative (manually stoked) boiler/fireplace



Option "Freeze guard" is enabled



"Freeze guard" triggered one of the pumps.



The burner start due to "freezing guard" is disabled in drop down menu, freezing protection system works without possibility for burner to work (use the boiler water without the possibility to heat it).



Since freezing guard is enabled, burner is started from the OFF phase. Snowflake disappears if burner is started by schedule, external start, Wifi monitoring, CMGSM, by pressing the ON/OFF button or if it goes to the OFF phase.

SYMBOLS, THE PARAMETERS ADJUSTING



3-way mixing valve with actuator and return flow temp. sensor + pump



Current status of existing elements of automatic / remote start is show on the screen (ON/OFF in a drop-down menu):

Shown in the picture:

- Schedule: enabled (status ON)
- Freezing guard: enabled (status ON)
- External control: enabled (status ON)
- WiFi/CM GSM: enabled (status ON)

By switching of a certain button to OFF:

- Schedule: disabled
- Freezing guard: boiler start for freezing protection is disabled, but freezing protection is working in a way it can perform without starting the boiler and a half of snowflake and an exclamation mark appear in the upper right corner of the screen
- External control: start from an external source is disabled and crossed external start icon is shown on the screen
- WiFi/CM GSM: boiler start/stop by WiFi/CM GSM module is disabled, other WiFi/CM GSM options are enabled

THE PARAMETERS ADJUSTING

There are 4 different menu types for adjusting the parameters:

A - this menu is used to set the parameters that have numerical values (°C, RPM, time...)

example: adjusting the boiler temp.

B - this menu is used to set parameters that must be selected (marked) to be enabled and there can be multiple selected (enabled) items

NOTE: some enabled options disable another one (they can't be enabled at the same time)

example: enable additional equipment: CAL, CM2K, Internet supervision...

C - this menu is used for view selecting options. Can only be changed under PIN (authorized service man)

example: DHW sensor type overview

D - this menu is used to set the parameters that must be selected but there can be only one selected item

example: Selection of the schedule table

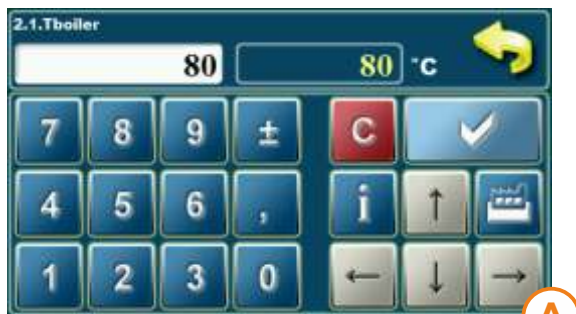

A



B



C



D

THE PARAMETERS ADJUSTING METHODS (examples)



- 1 - parameter you are adjusting
- 2 - value adjustment box
- 3 - set value
- 4 - value type
- 5 - info button (displays factory, min. and max. values)
- 6 - resets the current value to the factory value

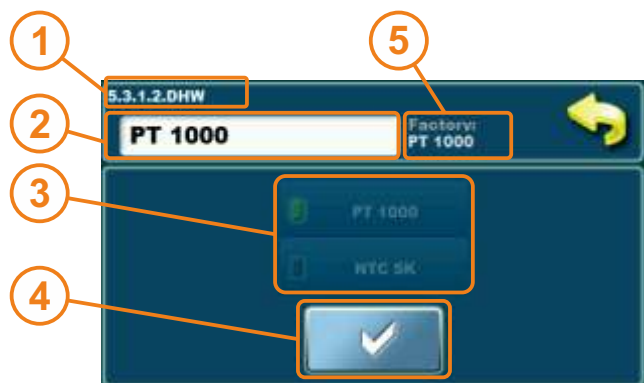

- 1 - parameter you are adjusting
- 2 - value adjustment box
- 3 - selected option (only one option can be selected)
- 4 - confirm button
- 5 - factory value



- 1 - parameter you are adjusting
- 2 - items that can be enabled
- 3 - next page button
- 4 - confirm button
- 5 - selected (enabled) item
- 6 - deselected (disabled) item



- 1 - parameter you are adjusting
- 2 - items that can be enabled (only one)
- 3 - confirm button
- 4 - selected (enabled) item (only one)
- 5 - deselected (disabled) item

NOTE: after parameter changing press the "CONFIRM" button to store new value. If you don't want to save the set value, press "BACK" button.

BURNER START PROCEDURE (START IS ENABLED)

The ways to activate "start is enabled" of the burner (burner goes from the OFF phase to the ST 0 phase (burner starts) or to the waiting phase (STANDBY)):

- manual activation by pressing the ON/OFF button
- activation by schedule (if enabled)
- activation by WiFi or CM GSM module (additional equipment) (if it is enabled in drop-down menu and in "Operation"/"Additional equipment"/"Internet supervision")

burner in the waiting phase "PAUSE" – causes:

- set boiler temperature is reached (controller waits the boiler temperature to drop below set difference)
- there is no heating demand (controller is set to start according to the heating demands)
- external control, that is enabled, turned the boiler off (controller awaits a request from external control)

Notes:

Burner may get into the "PAUSE" waiting phase right after start is activated (from the OFF phase) because one or more of the waiting phase causes are fulfilled.

BURNER STOP PROCEDURE / CONTROLLER STOP PROCEDURE

Correct ways to stop (turn off) the burner (get to the OFF phase):

- manual burner stop (turn off) by pressing "ON/OFF" button if burner is in any phase except the OFF phase (no matter if external control is enabled or disabled)
- burner stop (turn off) by schedule (if enabled) (no matter if external control is enabled or disabled)
- burner stop (turn off) by WiFi or CM GSM (additional equipment) (no matter if external control is enabled or disabled)

Correct controller stop (turn off) procedure (main switch 0/1)

- first thing to do is to get the burner into the "OFF" phase – the burner is turned off (unless it is already in that phase)
- switch off the main switch 0/1 (put it into the 0 position)



IMPORTANT NOTES!

- **the main switch (0/1) on the controller is not intended for switching the controller on and off.**
- **the burner must be in the "OFF" phase before switching the controller off on the main switch.**

1.0. MAINTENANCE



1.1. AIRVENT

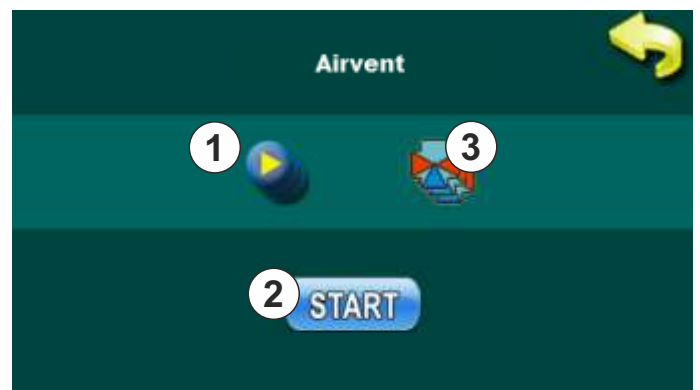
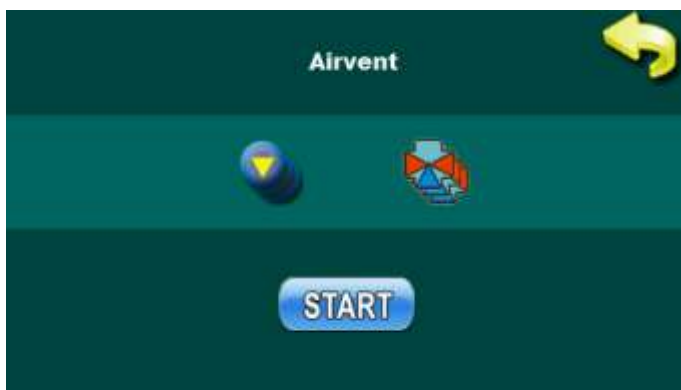

By entering the specified menu and pressing the "START" button (2), the motor actuator of all mixing valves and all pumps controlled by the boiler controller start working (motor actuator start by opening the mixing valves) (4), (6)), and the button "START" becomes the "STOP" key (5). By pressing the "STOP" button (5) the pumps and motor actuator stop operating ((1), (3)).

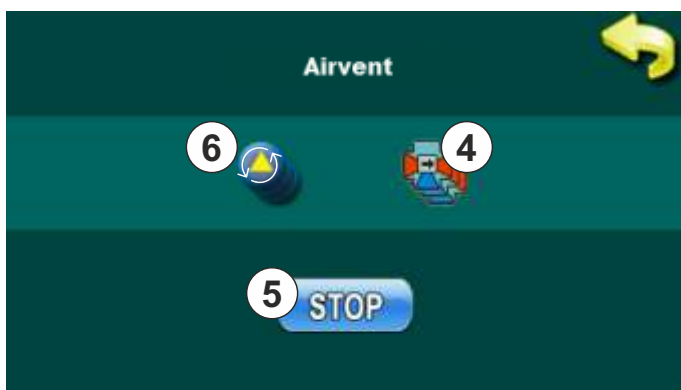

IMPORTANT!

Always after using the "AIRVENT" option, the boiler control must be switched OFF and ON again on the main switch (0/1) so that all motor actuator close the mixing valves automatically, which is done as standard each time the controller on the main switch (0/1) is switched ON.

2.0. TEMPERATURE



Temperature menu shows only items applicable to the set configuration. In next section of the manual all available configurations and schemes are listed.

Available temperature settings will be described at every individual configuration and scheme in "**CONFIGURATIONS**" section of this manual.

NOTE: this is only representation picture, actual possible adjustment depends on set configuration.

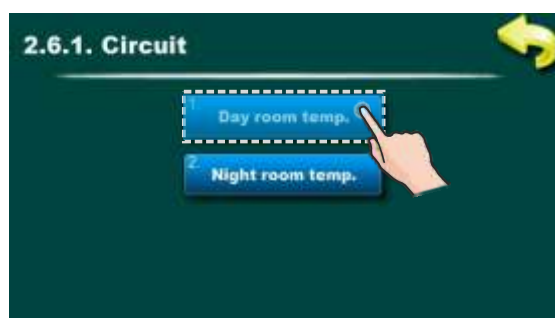

Possible adjustment:

Factory: 20.0°C

Option: 5.0 - 30.0°C

This sets up the first heating circuit daily room temperature.

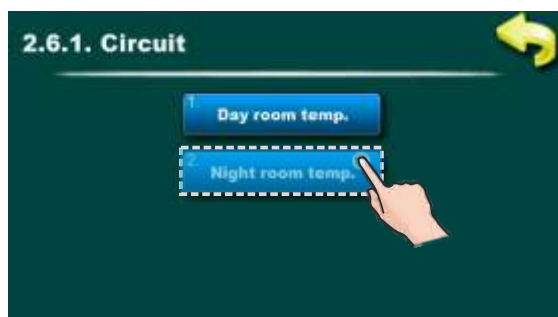

Possible adjustment:

Factory: 20.0°C

Option: 5.0 - 30.0°C

This sets up the first heating circuit night room temperature.

Abbreviations of individual temperatures - full name:

Tboiler: Boiler temperature

Tcro: Hydraulic crossover temperature

Tdhw: Domestic hot water temperature

dTdhw: Domestic hot water temperature difference

Tbuf: Buffer (accumulation) tank temperature

dTbuf: Buffer (accumulation) tank temperature difference

dTbuf-off: Temperature difference of the buffer (accumulation) tank to shut-off boiler pump when is burner is in "OFF" or "PAUSE" phase.

Tbuf min.: Minimum accumulation tank temperature below which consumer pumps do not operate

Recirk.-Tmin DHW: Minimum domestic hot water temperature below which the DHW recirculation pump does not operate

3.0. SCHEDULE



This option is used to set a working time of the burner, DHW tank heating, DHW recirculation pump and to change daytime and night time temperature of the first and the second heating circuit.

NOTE:

This manual shows the screen with the largest possible number of the basic boiler controller devices where schedule is available. An actual number of the devices with ordinal device numbers depends on chosen a selected configuration.

3.1. SCHEDULE - BOILER



This option is used to select a one of the three "SCHEDULE" tables you have set or to select **Schedule: OFF**

Possible adjustment: "SCHEDULE":

- Factory: OFF
- Table 1, Table 2, Table 3

NOTE:

You can adjust three different tables according to your needs, but one table can be active at the moment only.

3.1.2. TABLE 1/2/3

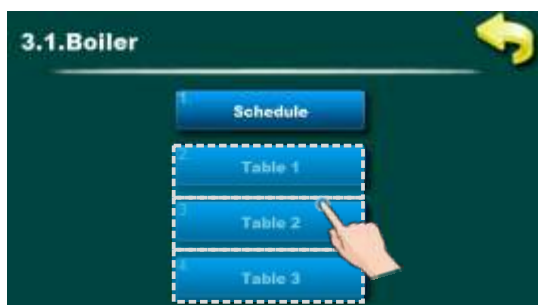

This option is used to set "SCHEDULE TABLES". Each table can be set individually. You can set ON/OFF 3 times during 1 day and every day can be individually set.

Schedule - Table 1						
MO.	TUE	WED	THU	FRI	SAT	SUN
06:00	06:00	06:00	06:00	06:00	06:00	06:00
22:00	22:00	22:00	22:00	22:00	22:00	22:00

COPY BUTTON PASTE BUTTON

- 1 - current table you are adjusting (table 1 / table 2 / table 3)
- 2 - day of the week
- 3 - green - burner start (on)
- red - burner stop (off)

Press the box to adjust the time

You can adjust 3 start and stop during 1 day

You can copy/paste from one day to another by pressing the "day box" of the day which you want to copy, press the "**COPY**" button and press the desired "day box" and press "**PASTE**" button.

3.2. DHW



This option is used to select a one of the three **SCHEDULE** tables you have set or to select **Schedule: OFF**

Setting up the table "SCHEDULE":

- **Factory: OFF**

- Table 1, Table 2, Table 3

NOTE:

You can adjust three different tables according to your needs, but one table can be active at the moment only. Each table can be set individually. You can set 3 starts and 3 stops of an active DHW period in a day.

3.3. RECIRCULATION



This option is used to select a one of the three **SCHEDULE** tables you have set or to select **Schedule: OFF**

Setting up the table "SCHEDULE":

- **Factory: OFF**

- Table 1, Table 2, Table 3

NOTE:

You can adjust three different tables according to your needs, but one table can be active at the moment only. Each table can be set individually. You can set 3 starts and 3 stops of an active DHW recirculation period in a day.

3.4. SCHEDULE – 1st heating circuit



This option is used for adjusting periods when room temperature is maintained. "Day temperature"/"Night temperature" or "Table" where switching from "Day temperature" to "Night temperature" is defined.

Possible adjustment:

- Factory: Day temperature
- Day temperature, Night temperature, Table

NOTE:

It is possible to adjust one table with different settings. In the table it is possible to set the three switch to "Day temperature" and three switch to "Night temperature" in one day.

3.5. SCHEDULE – 2st heating circuit

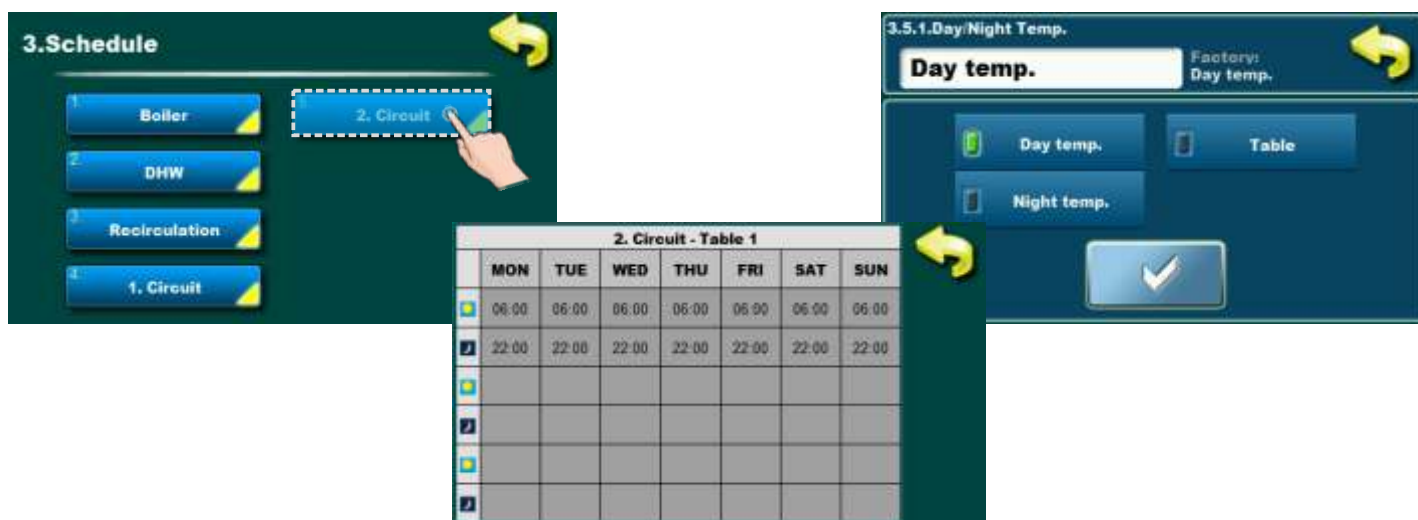

This option is used for adjusting periods when room temperature is maintained. "Day temperature"/"Night temperature" or "Table" where switching from "Day temperature" to "Night temperature" is defined.

Possible adjustment:

- Factory: Day temperature
- Day temperature, Night temperature, Table

NOTE:

It is possible to adjust one table with different settings. In the table it is possible to set the three switch to "Day temperature" and three switch to "Night temperature" in one day.

4.0. HISTORY



This option is used to see the history of the occurred "ERRORS" and "WARNINGS"

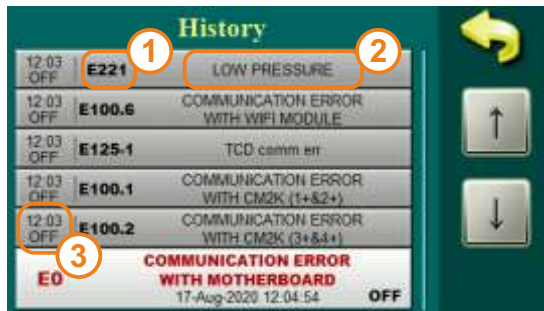

This option is used to see the history of the occurred "ERRORS".

- 1 - error code
- 2 - description of the error
- 3 - time and error of operation phase

Errors codes are marked with the letter "E".

List and the description of the errors can be found at the end of these instructions.



This option is used to see the history of the occurred "WARNINGS"

- 1 - error code
- 2 - description of the error
- 3 - time and working stage when warning occurred

Warning codes are marked with letter "W"

List and the description of the warnings can be found at the end of these instructions.

5. OPERATION MODE



This menu is used to set various parameters, enable/disable various additional equipment and functions, various work modes, manual test etc... This menu is designed for end user.

NOTE:

some of the options in this menu are GREYED OUT (disabled) and they can't be changed.

They are only shown to see settings/values of some options.

View in this menu depend of selected options and additional equipment.

5.1. MANUAL TEST

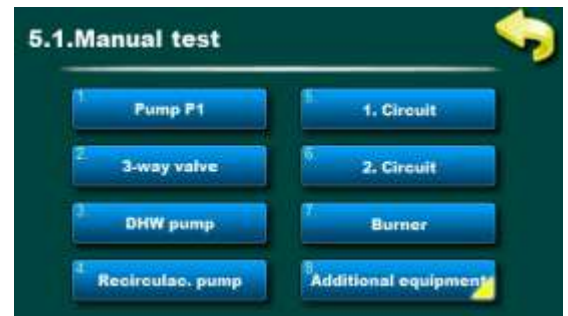

This menu is used to check the relay outputs, the connection to the electrical parts and the operation of the electrical parts of the boiler. Pressing the Start button starts the selected component, pressing the Stop component button stops functioning.

Parts:

- **pump P1 / DHW / RECIRCULATION:** the operation of all connected pumps can be checked

- **mixing valve (with actuator (return flow protection))**- the operation of the motor actuator of the mixing valve can be checked (backflow protection)

- when in the manual test (mixing valve) is pushed button "START" (close MV!) valve must close the water flow from the heating installation into boiler and open the bypass (case 1 or mirror image if the mixing valve is installed on the left side of the boiler).

- when in the manual test (mixing valve) is pushed button "START" (open MV!) valve must open the water flow from the heating installation into boiler and close the bypass (case 2 or mirror image if the mixing valve is installed on the left side of the boiler).

- **1. circuit / 2. circuit:** is possible to check the operation of all mixing heating circuit elements (pumps, opening / closing of actuator)

- **Burner:** the operation of the burner is checked, if the burner is two-stage the operation of the burner will be checked only in the first stage.

Manually stoked boiler: the operation of pump (P5) of the alternative (manually stoked) boiler/fireplace can be checked. The operation of the motor actuator of the mixing valve can be checked (return flow protection of alternative (manually stoked) boiler/fireplace)

- when in the manual test (mixing valve) is pushed button "START" (close MV!) valve must close the water flow from the heating installation into boiler and open the bypass (case 1 or mirror image if the mixing valve is installed on the left side of the boiler).

- when in the manual test (mixing valve) is pushed button "START" (open MV!) valve must open the water flow from the heating installation into boiler and close the bypass (case 2 or mirror image if the mixing valve is installed on the left side of the boiler).

- **Additional equipment:** menu for manual test of the installed additional equipment

NOTE: The display in this menu and the "ADDITIONAL EQUIPMENT" menu depends on the configuration selected and the installed additional equipment.

Case 1. 3-way mixing valve with actuator is 100% closed.

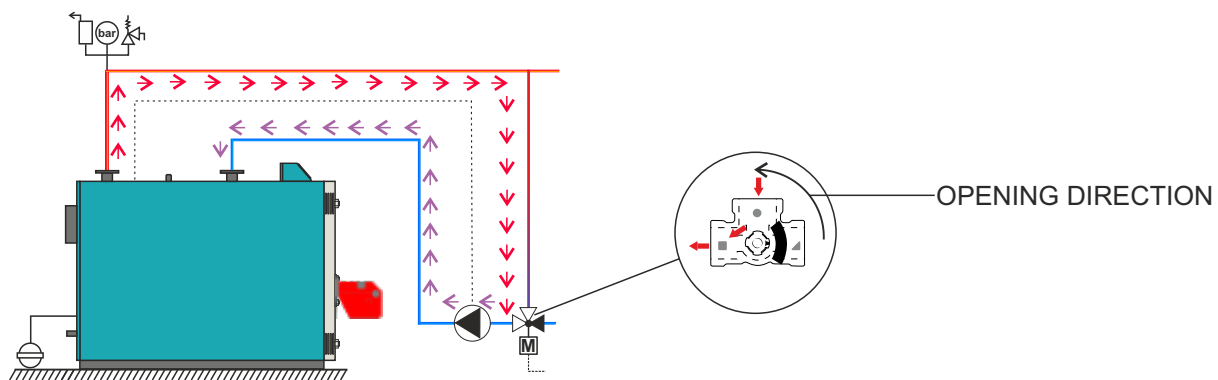

Case 2. 3-way mixing valve with actuator is 100% open.

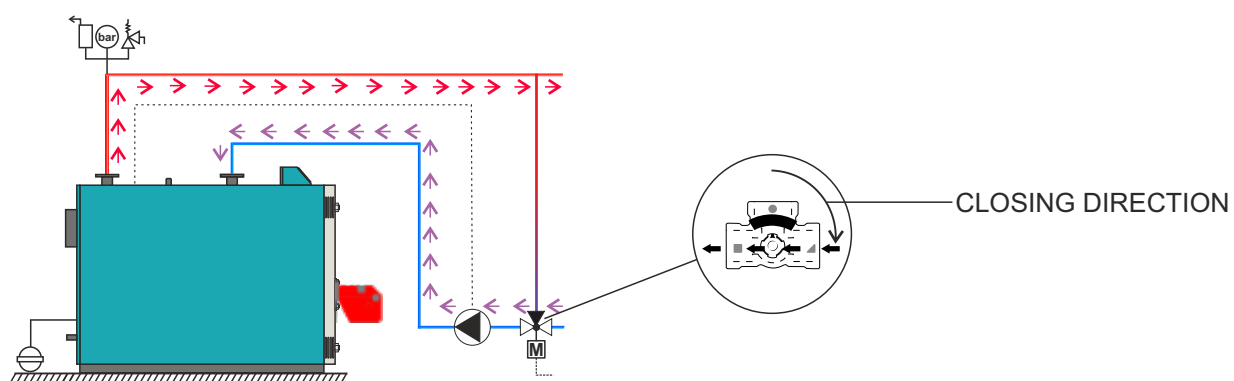

5.2. SAVE/LOAD



This option is used to save parameters, load / load service parameters and delete saved parameters.

SAVE - save current settings

LOAD - load saved setting

LOAD SERVICE - load setting authorized serviceman saved

DELETE - delete saved settings

You can save multiple setting under different names and you can load and delete saved setting.

5.3. STANDARD EQUIPMENT



This option is used for view (adjusting) standard equipment

Options:

- **Sensors** - it is only possible to view the type of sensor (PT1000 – factory or NTC 5K)

- **3-way valve** - (with actuator (backflow protection)) it is possible to check the settings: "Valve time" (opening time of 0-100%)

- **1st circuit / 2nd circuit** - the user settings of the heating circuits can be adjusted

- **DHW** - DHW can be set (on / off) and if recirculation is switch on can be set also "Recirculation operation time" and "Recirculation pause".

- **Manually stoked boiler** - alternative (manually stoked) boiler/fireplace can be adjusted (ON/OFF)

NOTE:

- some of the options in this menu are DISABLED and could not be changed. It only serves to view the set value. The display in this menu depends on the selected configuration (XYZ).



5.3.3/5.3.4. 1. CIRCUIT / 2. CIRCUIT





This option is used for adjusting the mixing heating circuits.

NOTE:
some parameters are shown in "OPERATION" menu but can't be changed. They can be changed only in "INSTALLATION" menu which is under PIN (only for authorized serviceman).

5.3.3.1 - 5.3.4.1 1. CIRCUIT / 2. CIRCUIT

It's possible to view all enabled mixing heating circuits (set temperatures, measured temperatures, heating type, working of the pumps etc...). To enter this view press  /  button and then .

If there are more than 2 mixing heating circuits enabled you can switch view between them with   buttons.

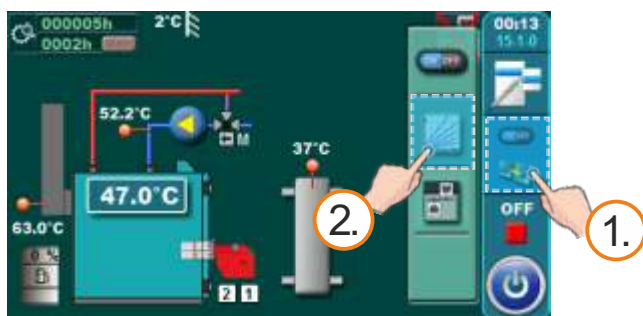

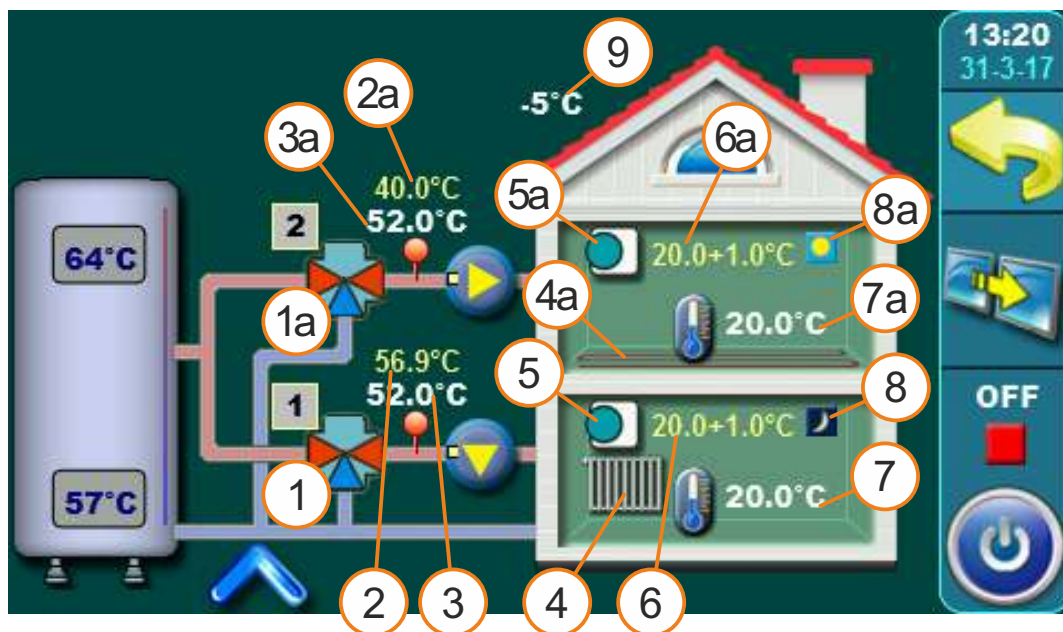

This schematic view is only possible to view, it is not possible to turn on / off / adjust individual elements. General: Specific elements can be individually adjusted and displayed for each heating circuit. For example: Turn on / off the heating circuit, turn on / off the room corrector, select the type of heating circuit for each circuit (radiator / floor), select the operation mode (daily / night).

- 1 - Mixing valve (1.circuit)
- 2 - The calculated flow temperature (1.circuit)
- 3 - Current measured main flow temperature (1.circuit)
- 4 - Heating type on 1. circuit (radiators (4) or floor (4a) heating)
- 5 - Room corrector „CSK“ on 1. circuit (if turned off, icon disappears)
- 6 - The desired temperature + deviation by room corrector (1.circuit)
- 7 - Current measured room temperature (shown only if the room corrector is turned on) in 1.circuit
- 8 - Mode (1.circuit) (day (8a) / night (8))
- 9 - Outer temperature (outer sensor)



Elements 1a - 8a have the same meaning as elements 1 to 8 (described above) refer only to the 2nd heating circuit or or any heating mixing circuit involved with respect to the number of circuits included.

5.3.X. MANUALLY STOKED BOILER

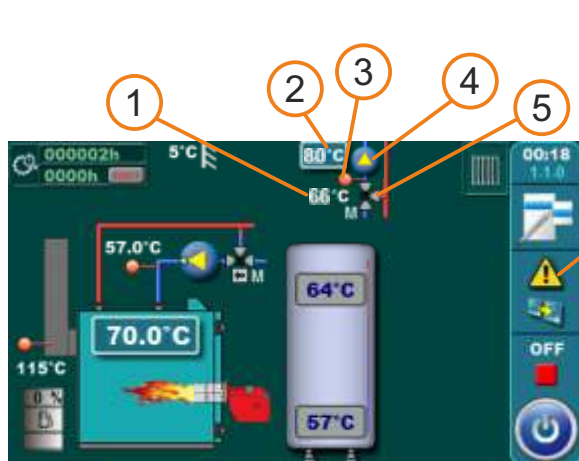

- 1 - Return flow temperature of alternative (manually stoked) boiler/fireplace
- 2 - Temperature of an alternative (manually stoked) boiler/fireplace
- 3 - Alternative (manually stoked) boiler/fireplace return flow sensor
- 4 - Pump (P5) of an alternative (manually stoked) boiler/fireplace
- 5 - Motor actuator of return flow safety of alternative (manually stoked) boiler/fireplace

SETTING PARAMETERS FOR EACH HEATING CIRCUIT

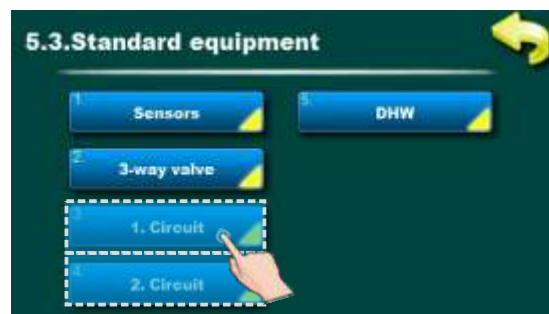

Controller can control up to two mixing heating circuits. They must be enabled and set under "INSTALLATION" menu. To make adjustment of each circuits go to the "OPERATION" menu then "STANDARD EQUIPMENT" menu.

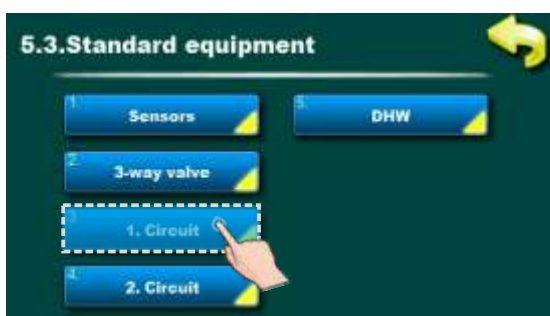

Possible selection:

Factory: ON

Option: ON, OFF

By using this option you can enable/disable heating circuits.

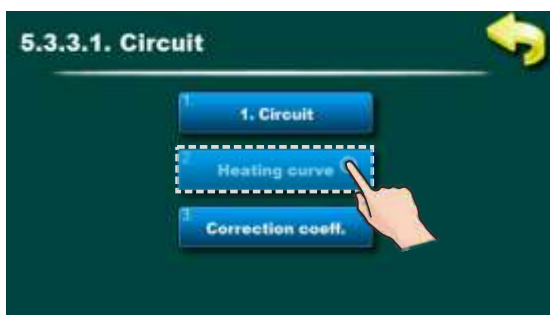

Possible selection:

Factory: 1.0

Option: 0.1 - 4.0

By using this option you can set heating curve value.

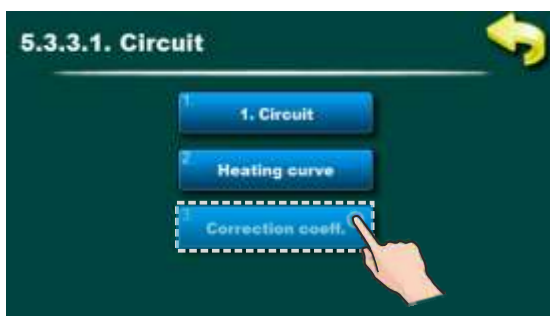

Possible selection:

Factory: 1.0

Option: 0,1 - 5,0

By using this option you can set correction value.

5.4. ADDITIONAL EQUIPMENT



This option is used to view the setting / setting of additional equipment that is not in the basic delivery (for most of the equipment the setting lowers on / off and detailed adjustment is performed by the authorized service person).

Options:

- **CM2K** - turn on/off CM2K (only for preview)
- **External control** - turn on/off external control (start) (only for preview)
- **CAL** - turn on/off alarm alert and setting up certain options (cannot be turned ON at the same time with Alternative boiler (burner) or EXT-2)
- **CM-GSM** - turn on/off CM-GSM module
- **Internet supervision** - turn ON/OFF internet supervision and setting up certain options
- **Fuel level** - ON /OFF fuel oil level in tank
- **Alternative boiler (burner)** - Alt. Boiler state (possible user choice) (cannot be turned ON at the same time with CAL or EXT-2)

NOTE:

Additional equipment must be selected in the "**INSTALLATION**" menu, and some of them must be first set/enabled (PIN required) and only then is it displayed in this menu. Some of the items shown here can be adjusted only under "**INSTALLATION**" menu and can be changed only by authorized serviceman.

5.4.4. INTERNET SUPERVISION

This option is used to connect controller to the internet trough Cm Wifi-box via WiFi network. Cm WiFi-box is additional equipment and is not part of standard delivery.

IMPORTANT NOTES:



CM WiFi-box requires active DHCP server of Access Point (e.g. router) because manual setting of network parameters is not possible. For more informations contact administrator of your home network.



For detailed configuration of the Cm WiFi box please refer to the Cm WiFi box manual received with the Cm WiFi box.

This option is used to set the controller to connect boiler to the internet through local Wi-Fi network.
This option is used to change internet supervision settings.
This option is only visible if "Cm WiFi box" is connected to the boiler controller by UTP cable.



When "Cm WiFi box" is connected to the boiler and internet supervision is enabled, a new icon appears on the main screen showing the status of internet supervision.

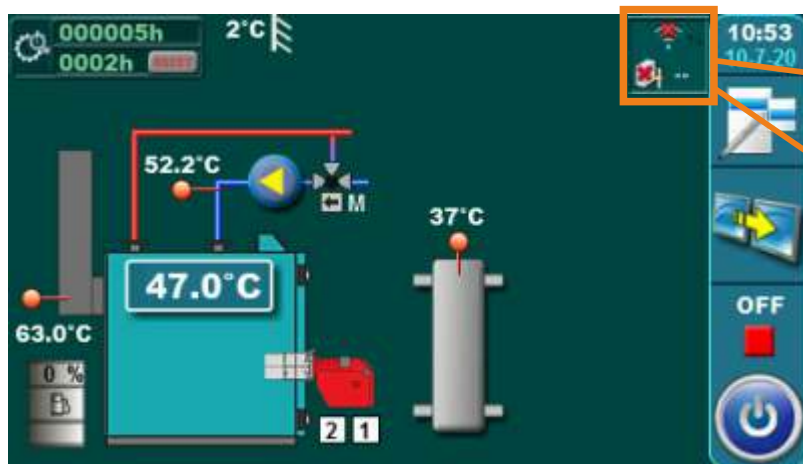

Controller is connected with web portal (internet supervision is possible)



Controller is not connected with web portal (internet supervision is not possible)

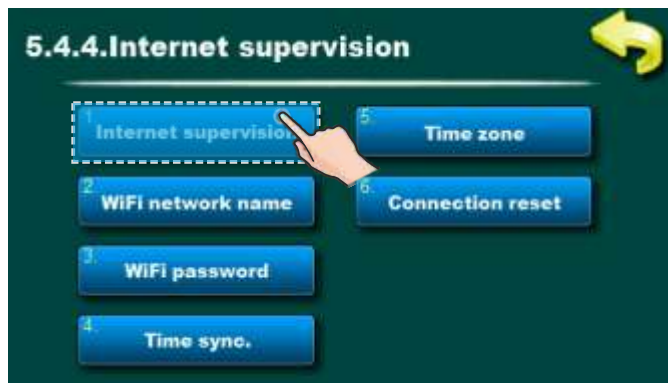

Factory: Supervision + control

OFF, Supervision, Supervision + control

This option is used to set and enable/disable internet supervision.

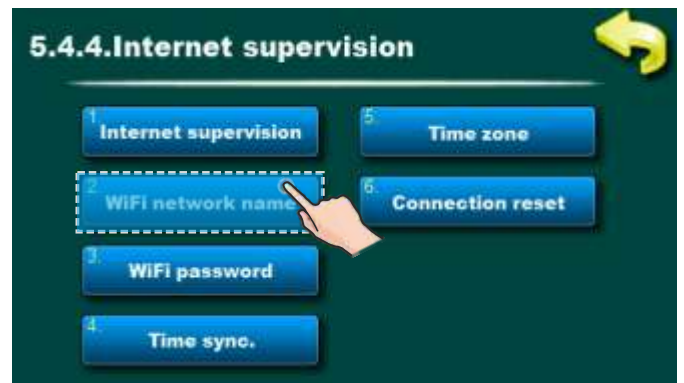

This option allows you to enter the name of WiFi home network to which you want to connect the "Cm WiFi box" and the boiler. You must enter exact WiFi network name or else boiler will not be able to connect to the WiFi network.

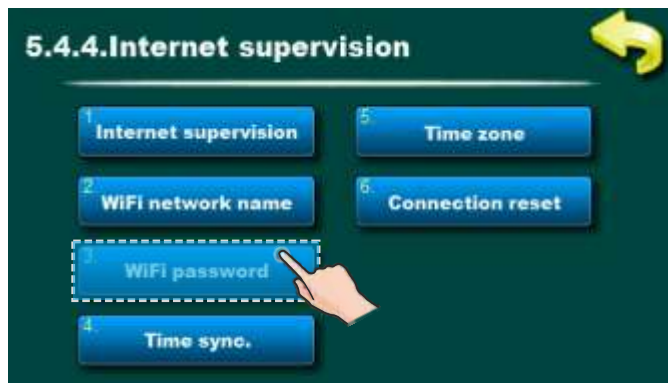

This option allows you to enter a password for your home Wi-Fi network. You must enter exact password or else boiler will not be able to connect to the WiFi network.



This option allows boiler time synchronization with web server time (internet time).

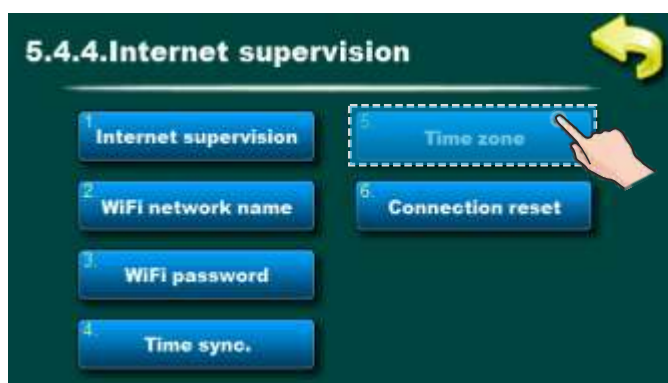

This option allows you to set the time zone if the boiler is in a different time zone than the web portal server. (this option must be set if you enable "Time synchronisation option")

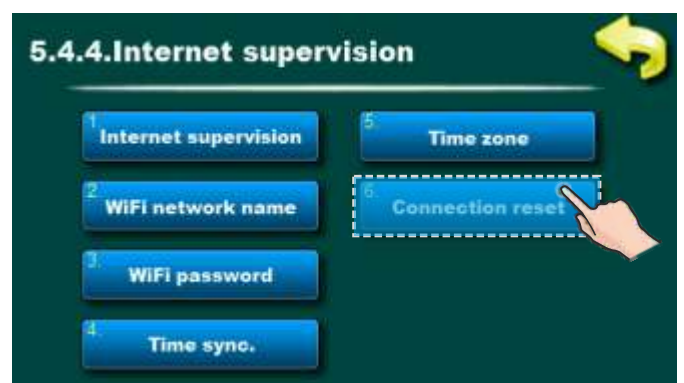

This option allows you to reset connection with home network.

5.4.6. ALTERNATIVE BOILER (available from software v1_06h and later)

Option - "Alternativni boiler (burner)":

- The "Alternative boiler" option can only be used if the CUPREG-Touch control is installed on both, the basic (main) boiler and the alternative boiler.
- On the CUPREG-Touch controller of the **basic (main)** boiler the authorized service technician must select "Alternative boiler (burner)" (Installation/Commissioning/Configuration/Additional equipment – Alternative boiler (burner)) and additionally turn it ON (Installation/Electrical devices/Additional equipment/Alternative boiler (burner) - ON
After that, the CUPREG-Touch controller must be switched OFF/ON at the main switch (0/1).
- On the CUPREG-Touch controller of the **ALTERNATIVE** boiler, the authorized service technician must activate "External control" (Installation/Commissioning/Configuration/Additional equipment - External control - Enabled (factory is disabled)

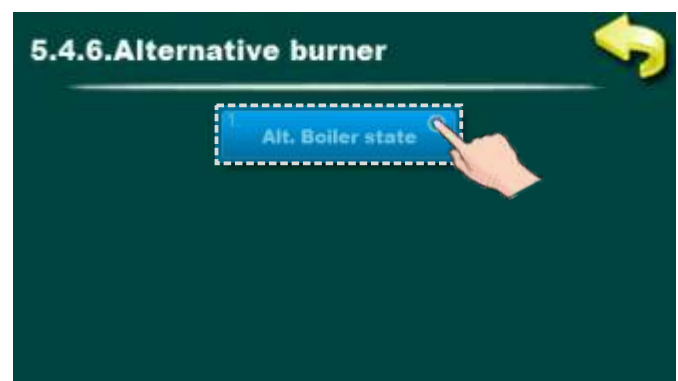

Alt. Boiler state (possible choice, can be selected by the user):

- factory: AUTO START

Possible choice: Manual OFF, Manual ON, AUTO START, OFF, ON, FREEZE ON

AUTO START – The controller of the basic (main) boiler will give a request for the operation of the alternative boiler if the basic (main) boiler (boiler with this controller) needs to work, and the occurrence of a error on the basic (main) boiler does not allow its operation.

Manual OFF – the option to switch ON the alternative boiler is switched OFF manually (basic (main) boiler controller will not switch ON an alternative boiler)

Manual ON – The controller of the basic (main) boiler permanently requires the operation of an alternative boiler

OFF – The AUTO START of basic (main) boiler gives an order to the controller to switch ON the alternative boiler, but it was switched OFF by the schedule of the basic (main) boiler or the external start (external control) of the basic (main) boiler. After the schedule or external start (external control) of the basic (main) boiler requests boiler operation the state "OFF" goes into the state "ON" and controller gives a request for the operation of an alternative boiler.

ON – The controller of the basic (main) boiler gives a request for the operation of the alternative boiler. This state can be automatically changed only to the state "OFF" if the switch-off time of the basic (main) boiler or external start (external control) of the basic (main) boiler is switched, the state returns to "ON" when the switch-on schedule or external start (external control) of the basic (main) boiler request boiler operation.

Freeze ON – if the state "FREEZE ON" has been selected when the need for operation of the basic (main) boiler due to freeze on protection, basic (main) controller gives a request for the operation of an alternative boiler and the state goes to "ON".

Important!

When the state "ON" or "OFF" is selected, it is considered that the basic (main) boiler has requested the operation of an alternative boiler (which means that there is a delay in the operation of the basic (main) boiler) only by manual selection it is possible to change these states.

Control (user) with alternative boiler, independent of the main boiler.

1. Alternative boiler has configured external control (standard for alternative boiler).
2. In the drop-down menu, enter the external start management option.
3. Disable external start (set to OFF).
4. External start is disabled.
5. The user can switch the boiler on/off using the ON/OFF button independently of the main boiler.



Returning control over the alternative to the main boiler:

6. In the drop-down menu, enter the external start management option.
7. Enable external start (set to ON).
8. External start is enabled.
9. The alternative boiler works according to the requirements of the main boiler.

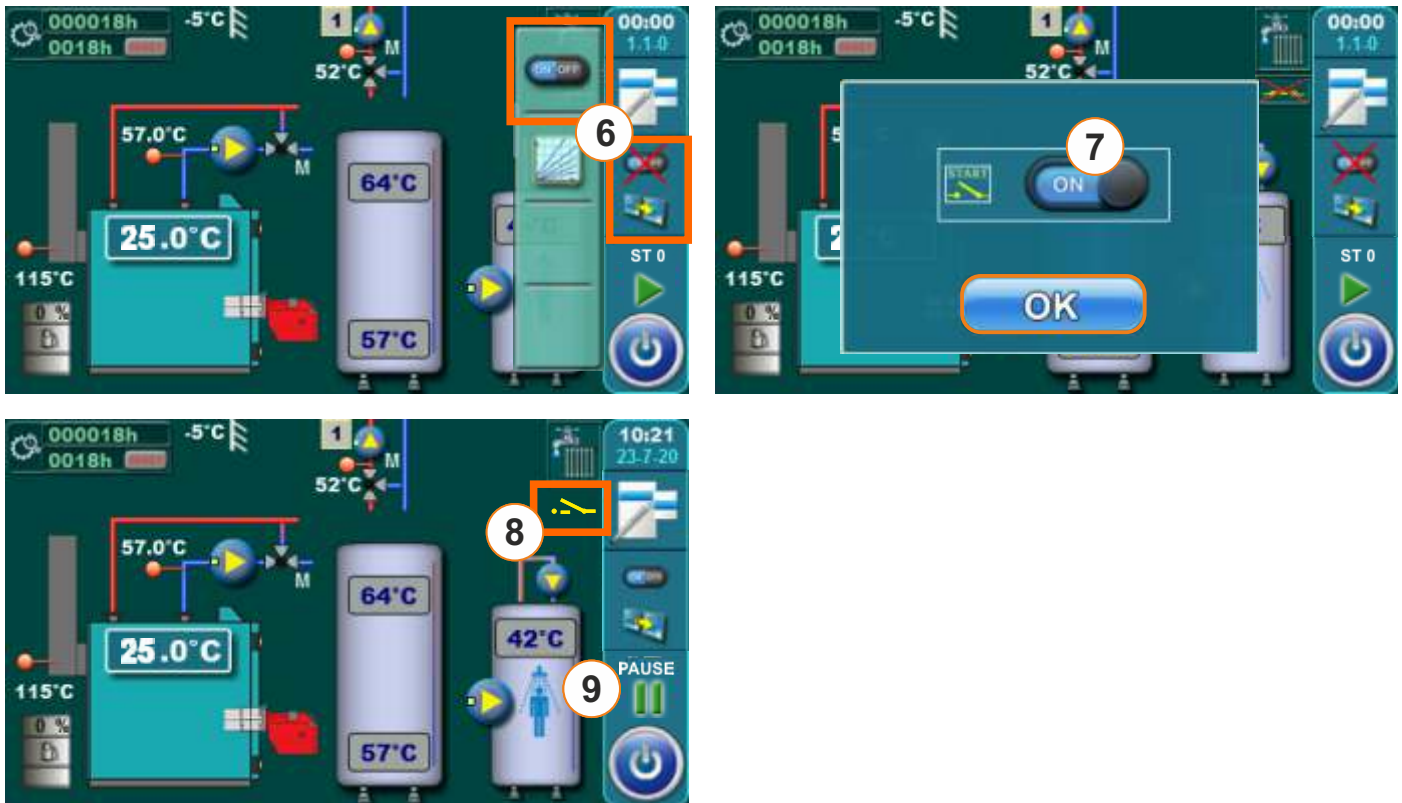
**5.5.1. FREEZE GUARD****Possible selection:****Factory: OFF**

Options: OFF, ON

While Freeze guard option is enabled, controller monitors minimum set temperature of each sensor in boiler and equipment attached to controller and, in case that Toutside option is enabled, controller also monitors minimum outside temperature. If temperature drops below set value, controller starts pumps and the boiler if needed.

While Freeze guard option is enabled and particular pump are selected in submenu Option, if particular system components are disabled (ie. DHW tank...), those components are display in grey on the Main screen. The pumps that supply those disabled components will be started due to Freeze guard option. The pumps started due to Freeze guard option have no additional marking in their symbols.

In case the Freeze guard option is enabled, but a heating circuit is disabled, a number by the heating circuit is crossed and the heating circuit is started due to Freeze guard option.

5.5.2. Toutside



While Freeze guard option is enabled, controller monitors minimum set temperature of each sensor connected to the controller and the minimum set outside temperature. While Toutside is disabled, the Freeze guard option will monitor minimum set temperature of the boiler and equipment only.

Enabling and disabling of this option can be provide under INSTALLER (PIN), a customer has just possibility to view this option.

5.5.3. OPTION



If both Freeze guard and Toutside options are enabled, a customer has an opportunity to enable particular pump (each pump must be selected separately) while minimum outside temperature drops below set value. In menu are displayed all active pumps that can be selected. If there is a defect on outside temperature sensor or if it is disabled, but Toutside option is enabled, the situation will be considered as fulfilled outside temperature condition and the pumps will be enabled to work.

5.5.4. TEMPERATURE



Freeze guard (set temperatures preview):

Tsensor_min - minimum temperature of an each sensor to start the Freeze guard

dTsensor_min - minimum temperature difference of an each sensor

Toutside_min - minimum outside temperature to star the Freeze guard

5.6. WORK MODE



This option enables to set working mode

Possible selection:

- **Factory: Heating+DHW** (unless the basic equipment doesn't have any heating circuit)
- Options: Heating+DHW, AUTO DHW<->Heat. + DHW, DHW

Heating+DHW - this mode is possible if there are both heating circuits and DHW, the heating and DHW tank are controlled according to set conditions.

AUTO DHW<->Heat.+DHW - This mode is possible if there are both heating circuits and DHW, the controller changes Heating+DHW and DHW mode according to set conditions (outside temperature) and it automatically adjusts the system to the selected working mode and to the selected working mode conditions.

DHW - this mode is possible if there are both heating circuits and DHW, but DHW mode is manually or automatically selected, or there are no heating circuits, just DHW.

Note:

If you really want to use DHW in DHW mode via CM2K, all heating circuits must be manually disabled in CM2K and Heating+DHW mode must be selected

5.7. DHW PRIORITY



DHW priority- the boiler works according to the heating and DHW requirements, but with DHW priority

5.8. PUMP PROTECTION

This option enables protection of the pumps/valves from blocking during long stand-still (usually during summer season when heating is off).

Enabling this option and setting the maximum idle time of the output to the pumps / valves can be done under the menu **5. Operation -> 5.8. Pump protection**.

Factory this option is enabled and max. stand-still time of outputs is set to 48 hours. According to this setting, any pump/valve output that is not activated in 48 hour, it will be activated for duration of 60 seconds. When certain output is activated it's stand-still time is reset.

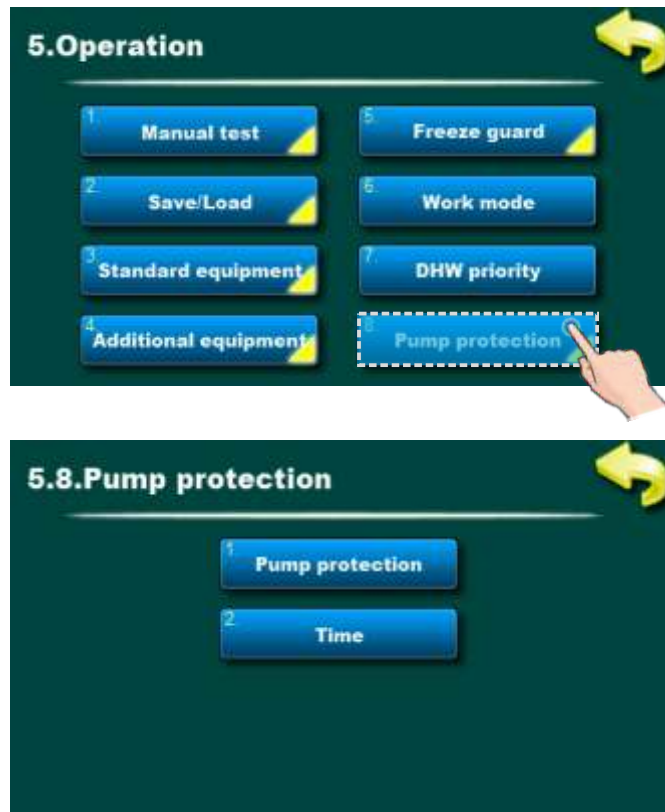

6. DISPLAY



This option is used to set display/sound parameters.

Options:

- **Screensaver** - a time period after which screensaver shows for protecting the screen due to displaying the same image for a long time. By touching the screen Screensaver disappears and the next screensaver time period countdown starts after the last touch. If there is an "Error/Warning" Screensaver disappears and the next screensaver time period countdown starts after an error/warning is confirmed to be seen by a customer or after the last touch.

- **Language selection** - this menu enables or disables displaying of the language selection screen as an initial screen after the controller is switched on. If 'OFF' is selected, the controller will be switched on in the pre-set language and after a certain period of time, 'Initial message time', the main screen will appear. During the first commissioning, an authorized serviceman will select preferred language and disable Language selection option to allow the controller to automatically start after electricity gets back. If Language selection is not disabled, after electricity gets back, the controller will wait a customer to select the preferred language and then continue to work.

- **Initial message time** - time period setup after controller is switched on in case the Language selection option is disabled (after that time main screen will be displayed). Time is counted if Language selection option is disabled only.

- **Show timers** - this option allows a customer to have the timer of each working phase displayed in the main screen. This option makes it easier to monitor working phases of the burner and other components.



- **Date & Time** - current time and date adjusting. If those parameters are not correct, the scheduled times will not work properly. If time gets reset to 00:00 and date is 1.1.2000. it is necessary to replace the battery on the controller display (CR1220). The clock could be faster/slower (the shift could be 2-3 minutes per month), which is considered normal and we recommend that you adjust it periodically.

- **Sound volume** - to set one of the 3 volume levels or turn the sound off.

- **Sound type** - to select one of the 10 types of the sound.

7. INFO



This option is used to see various informations regarding regulation and burner.

Options:

- **Statistics** - here are shown working times of various boiler elements (burner operation time / burner mode DHW only / burner freeze guard / burner start / burner fan working time / igniter work time / number of igniter starts / pump P1 work time)
- **Software version** - it can be see controller software and WiFi ID number (if it installed Cm WiFi-box)
- **Selected configuration** - it can be see currently selected configuration
- **Current file** - it can be see which saved file is currently in use
- **Burner power reg.** - it can be see currently set burner power (it can be selected by an authorized serviceman only – under PIN)
- **Tboiler max** - it can be see the maximum boiler temperature

8. CM2K



This option is only visible if it is activated in "Installation men." "Access to the Installation menu has only authorized person (by entering PIN)".

For more informations about this menu see "Technical instructions, Module for control of two heating circuits (CM2K)".

9. INSTALLATION



This menu is used only by authorized servicemen. For entry in **"INSTALLATION"** menu is necessary to input PIN.

10. BURNER WORKING STAGES

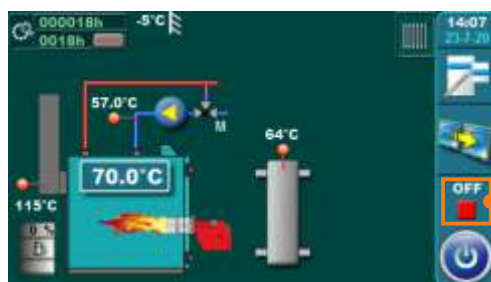

Burner working stage

- "OFF"** - the burner is OFF, not working
- "ST 0"** - start of the burner, the burner is ordered to turn on the first stage, waiting for a return signal (confirmation) from the burner that it succeeded ignite the first stage
- "ST 1"** - work in the first stage
- "ST 2"** - work in the second stage (only for two-stage burners)
- "ST1>2"** - transition from the first stage to the second (time from the burner request to turn on the second stage until the burner confirms that it has succeeded ignite the second stage)
- "ST2>1"** - transition from the second to the first stage
- "ST1>0"** - transition from first stage to OFF
- "ST M"** - burner operation (only for modulation burners)
- "PAUSE"** - waiting phase (STANDBY) - the burner is waiting for some of the conditions for the start (diff. boiler, hydraulic crossover, acc. tank, heating, DHW ...)

11. HEATING CONFIGURATION (markings on the display)

CONFIGURATION MARKINGS IN GENERAL: **XYZ**

Marking description on the individual positions:

X__ - the mark on the first position indicates the mode of the boiler connection on the heating installation (return line safety):

- A** - marks the boiler connection with the HYDRAULIC CROSSOVER + SENSOR via the 3 way valve with actuator (return line safety)
- B** - marks the boiler connection with the ACCUMULATION TANK via the 3 way valve with actuator (return line safety)
- C** - marks the boiler connection with the HYDRAULIC CROSSOVER via the 3 way valve with actuator (return line safety)

__**Y** - the mark on the second position indicates if the basic boiler controller steers the production of DHW and recirculation of the DHW and in which form (it is not taken into account one or more CM2K – modules for two heating circuits / DHW)

- 0** - there is no DHW and no recirculation of DHW
- 1** - a DHW tank exists beyond the boiler
- 2** - a DHW tank exists beyond the boiler and the recirculation of DHW

__**Z** - the mark on the third position indicates if basic controller steers the central heating circuits or circuit of alternative boiler-manually stoked boiler/fireplace on biomass, if it steers describes the type and number of circuits (does not consider one or more CM2K modules for two heating circuits/DHW):

- 0** - the boiler controller does not steer central heating circuits with mixing valves, but with additional selection it can be operated with one or two central heating circuits
- 1** - the boiler controller steer with one central heating circuit with the mixing valve
- 2** - the boiler controller steer with two central heating circuit with the mixing valve
- 3** - the boiler controller steer with one central heating circuit with the mixing valve and one ALTERNATIVE (MANUALLY STOKED) BOILER/FIREPLACE on biomass with mixing valve
- 4** - the boiler controller steer with one central heating circuit of ALTERNATIVE (MANUALLY STOKED) BOILER/FIREPLACE on biomass with mixing valve

Several examples of selected configurations (to help you understand the above description)

Example 1:

Configuration A01 - boiler connected with HYDRAULIC CROSSOVER + SENSOR via a 3-way valve with motor (backflow protection), and single central heating circuit control with mixing valve.

Example 2:

Configuration A02 - boiler connected with HYDRAULIC CROSSOVER + SENSOR via a 3-way valve with motor (backflow protection), and control of two mixing central heating circuits.

Example 3:

Configuration A20 - boiler connected with HYDRAULIC CROSSOVER + SENSOR via a 3-way valve with motor (backflow protection), DHW tank with DHW recirculation and it is possible to control one or two direct central heating circuits (if one or more CM2K modules for two heating / DHW circuits are not installed)

The "CONFIGURATION" show only the heating and DHW circuits from the basic boiler equipment, they do not include the embedded heating / DHW circuits through the installation of additional equipment - additional CM2K heating controllers or some others. Viewing the selected configuration is possible by entering main menu in "7. Info" / "7.3 Selected configuration".

11.1. CONFIGURATION A-0-0

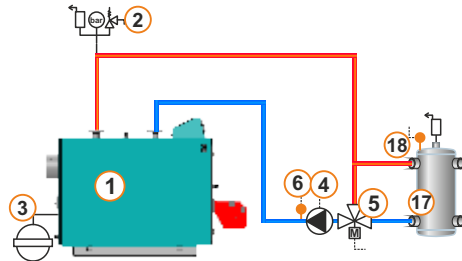
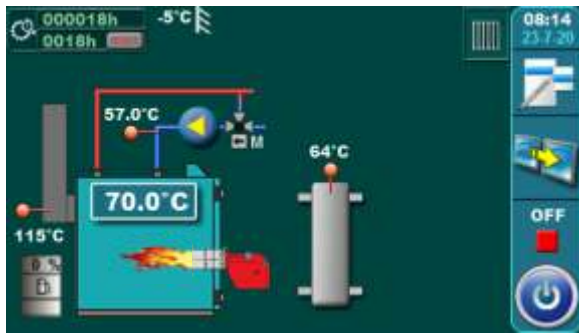

Temperatures: Tboiler: 80°C (75-100°C)
Boiler t. Difference: 5°C (5-20°C)
Tcro: 75°C (65-100°C)

Note: the selected temperature of the hydraulic crossover (**Tcro**) cannot be higher than the selected temperature of the boiler (**Tboiler**).

11.2. CONFIGURATION A-0-1

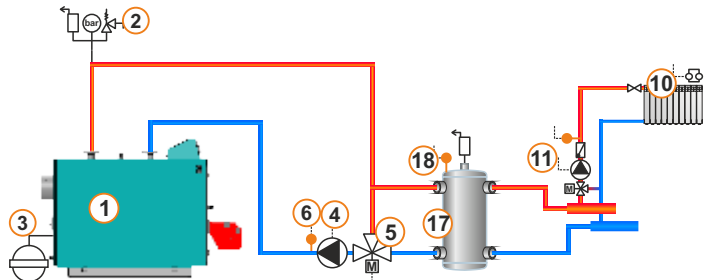
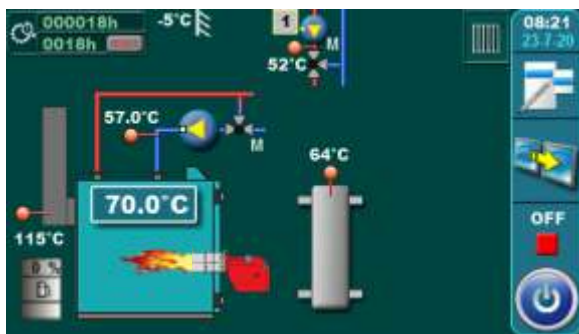

Temperatures: Tboiler: 80°C (75-100°C)
Boiler t. Difference: 5°C (5-20°C)
Tcro: 75°C (65-100°C)

1. Circuit:
Const. temp. day: 60°C (20-90°C)
Const. temp. night: 60°C (20-90°C)
Day room temp.: 20°C (5-30°C)
Night room temp.: 20°C (5-30°C)

Note: the selected temperature of the hydraulic crossover (**Tcro**) cannot be higher than the selected temperature of the boiler (**Tboiler**).

11.3. CONFIGURATION A-0-2

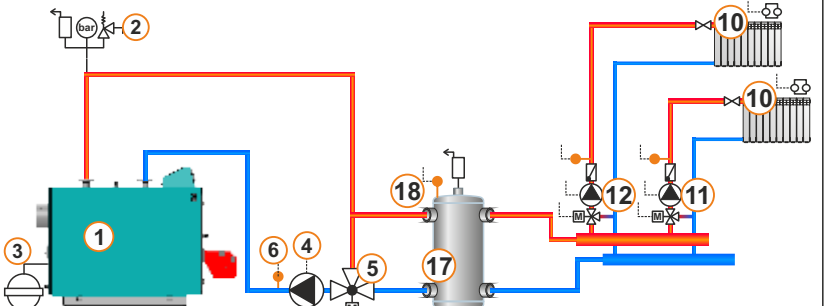
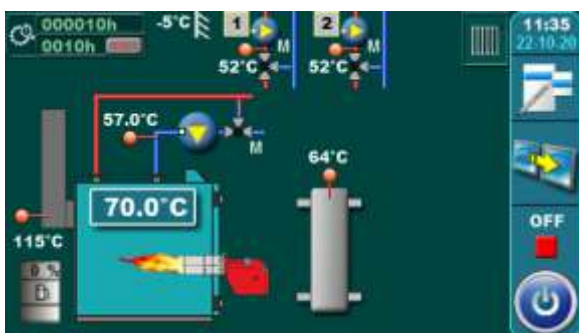

Temperatures: Tboiler: 80°C (75-100°C)
Boiler t. Difference: 5°C (5-20°C)
Tcro: 75°C (65-100°C)

1. Circuit, 2. Circuit:
Const. temp. day: 60°C (20-90°C)
Const. temp. night: 60°C (20-90°C)
Day room temp.: 20°C (5-30°C)
Night room temp.: 20°C (5-30°C)

Note: the selected temperature of the hydraulic crossover (**Tcro**) cannot be higher than the selected temperature of the boiler (**Tboiler**).

11.4. CONFIGURATION A-1-0

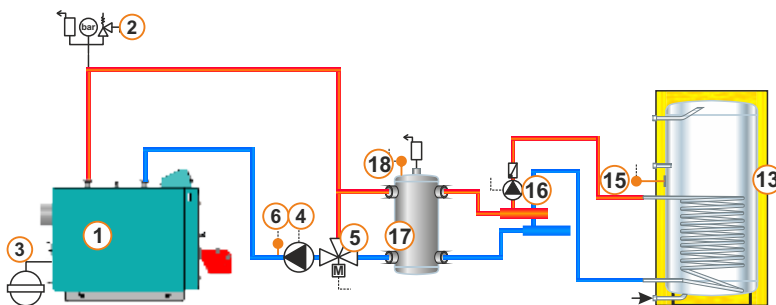
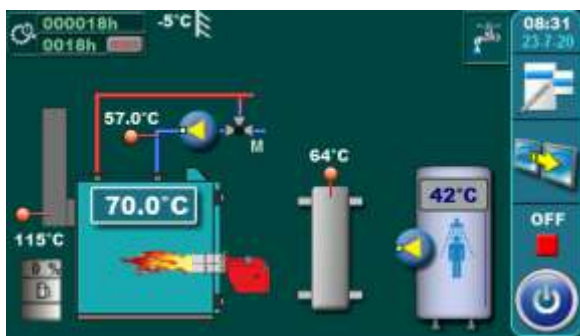

Temperatures: Tboiler: 80°C (75-100°C) dTdhw: 5°C (5-50°C)
 Boiler t. Difference: 5°C (5-20°C)
 Tcro: 75°C (65-100°C)
 Tdhw: 50°C (10-73°C)

Note: the selected temperature of the hydraulic crossover (**Tcro**) cannot be higher than the selected temperature of the boiler (**Tboiler**).

11.5. CONFIGURATION A-2-0

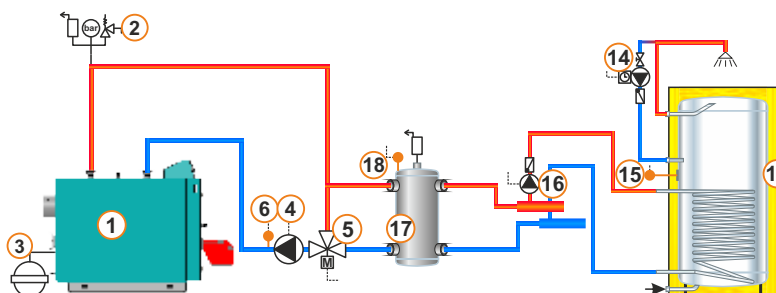
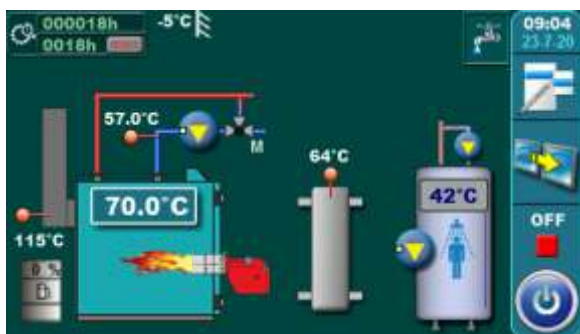

Temperatures: Tboiler: 80°C (75-100°C) dTdhw: 5°C (5-50°C)
 Boiler t. Difference: 5°C (5-20°C) Recirk.-Tmin DHW: 35°C (10-60°C)
 Tcro: 75°C (65-100°C)
 Tdhw: 50°C (10-73°C)

Note: the selected temperature of the hydraulic crossover (**Tcro**) cannot be higher than the selected temperature of the boiler (**Tboiler**).

11.6. CONFIGURATION A-1-1

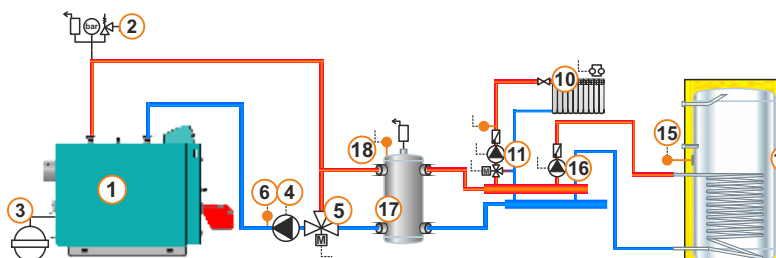
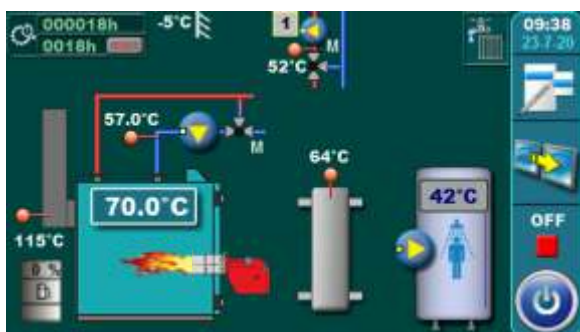

Temperatures: Tboiler: 80°C (75-100°C) 1. Circuit:
 Boiler t. Difference: 5°C (5-20°C) Const. temp. day: 60°C (20-90°C)
 Tcro: 75°C (65-100°C) Const. temp. night: 60°C (20-90°C)
 Tdhw: 50°C (10-73°C) Day room temp.: 20°C (5-30°C)
 dTdhw: 5°C (5-50°C) Night room temp.: 20°C (5-30°C)

Note: the selected temperature of the hydraulic crossover (**Tcro**) cannot be higher than the selected temperature of the boiler (**Tboiler**).

11.7. CONFIGURATION A-1-2

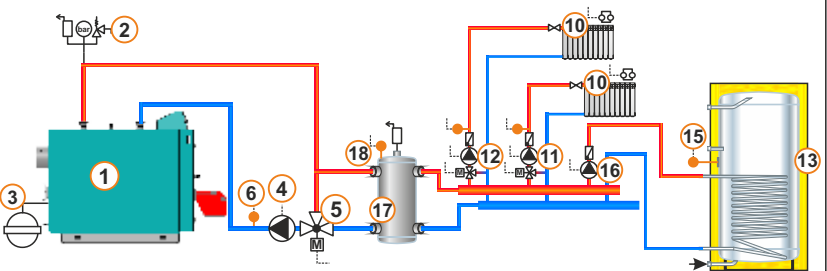
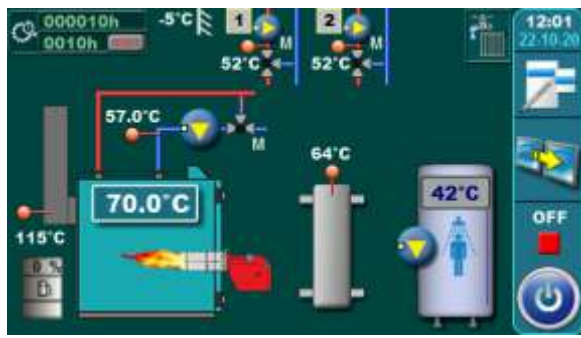

Temperatures: Tboiler: 80°C (75-100°C)
 Boiler t. Difference: 5°C (5-20°C)
 Tcro: 75°C (65-100°C)
 Tdhw: 50°C (10-73°C)
 dTdhw: 5°C (5-50°C)

1. Circuit, 2. Circuit:
 Const. temp. day: 60°C (20-90°C)
 Const. temp. night: 60°C (20-90°C)
 Day room temp.: 20°C (5-30°C)
 Night room temp.: 20°C (5-30°C)

Note: the selected temperature of the hydraulic crossover (Tcro) cannot be higher than the selected temperature of the boiler (Tboiler).

11.8. CONFIGURATION A-2-1

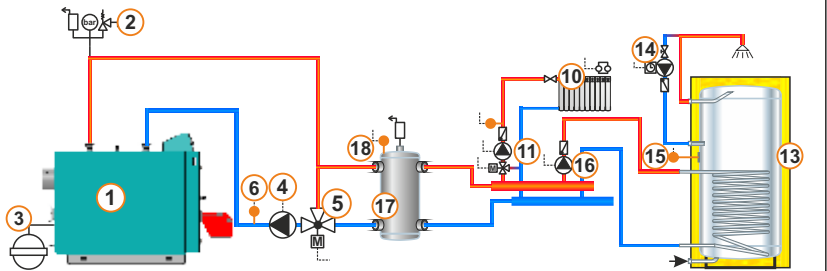
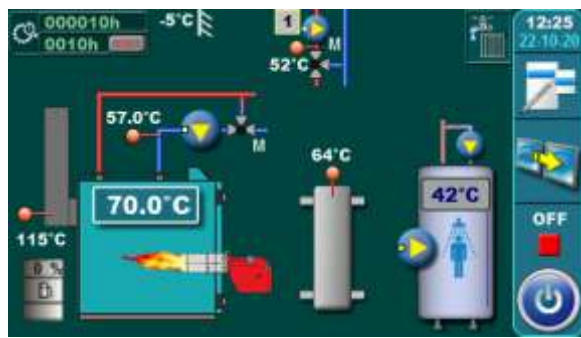

Temperatures:
 Tboiler: 80°C (75-100°C)
 Boiler t. Difference: 5°C (5-20°C)
 Tcro: 75°C (65-100°C)
 Tdhw: 50°C (10-73°C)
 dTdhw: 5°C (5-50°C)

1. Circuit:
 Const. temp. day: 60°C (20-90°C)
 Const. temp. night: 60°C (20-90°C)
 Day room temp.: 20°C (5-30°C)
 Night room temp.: 20°C (5-30°C)

Recirk.-Tmin DHW: 35°C (10-60°C)

Note: the selected temperature of the hydraulic crossover (Tcro) cannot be higher than the selected temperature of the boiler (Tboiler).

11.9. CONFIGURATION A-2-2

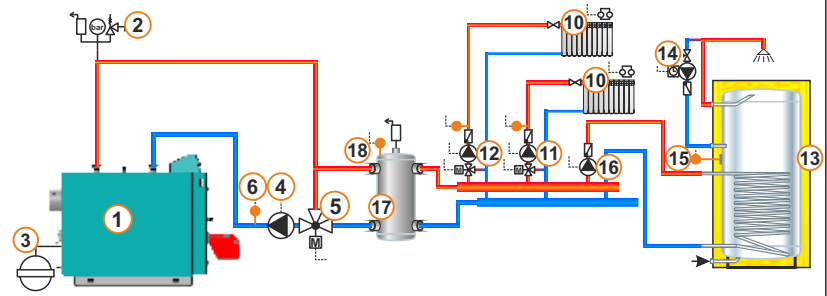
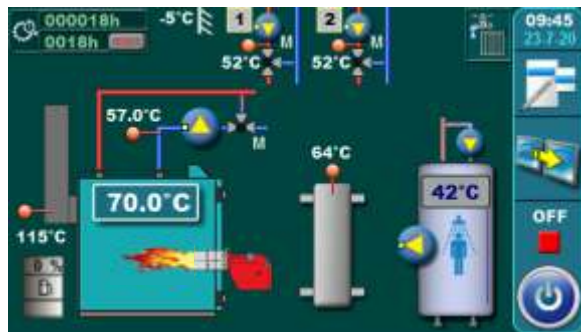

Temperatures:
 Tboiler: 80°C (75-100°C)
 Boiler t. Difference: 5°C (5-20°C)
 Tcro: 75°C (65-100°C)
 Tdhw: 50°C (10-73°C)
 dTdhw: 5°C (5-50°C)

1. Circuit, 2. Circuit:
 Const. temp. day: 60°C (20-90°C)
 Const. temp. night: 60°C (20-90°C)
 Day room temp.: 20°C (5-30°C)
 Night room temp.: 20°C (5-30°C)

Recirk.-Tmin DHW: 35°C (10-60°C)

Note: the selected temperature of the hydraulic crossover (Tcro) cannot be higher than the selected temperature of the boiler (Tboiler).

11.10. CONFIGURATION B-0-0

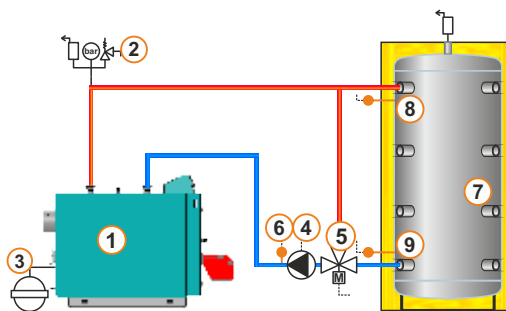
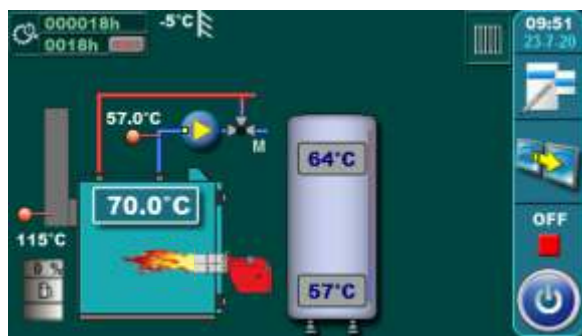

Temperatures: Tboiler: 80°C (80-100°C) dTbuf: 10°C (5-30°C)
 Boiler t. Difference: 5°C (5-20°C) dTbuf-off: 5°C (3-50°C)
 Tbuf: 80°C (70-100°C)

Note: the selected temperature of the accumulation tank (buffer) (Tbuf) cannot be higher than the selected temperature of the boiler (Tboiler).

11.11. CONFIGURATION B-0-1

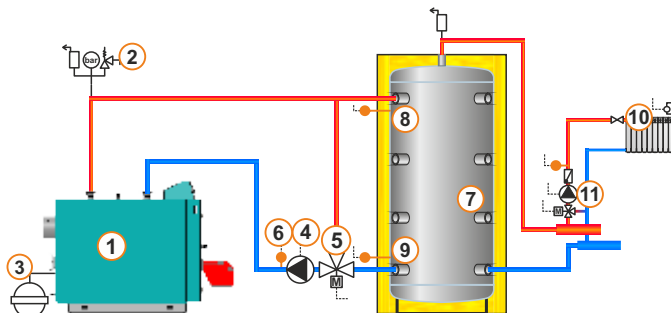
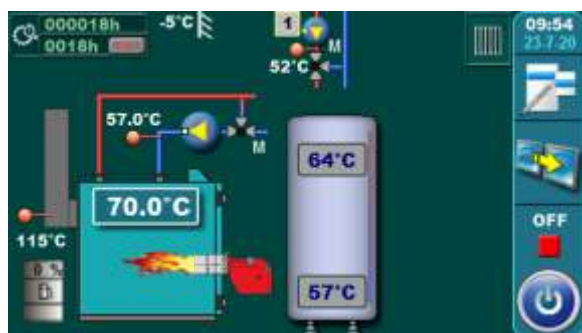

Temperatures: Tboiler: 80°C (80-100°C) Tbuf min.: 20°C (5-85°C)
 Boiler t. Difference: 5°C (5-20°C) 1. Circuit:
 Tbuf: 80°C (70-100°C) Const. temp. day: 60°C (20-90°C)
 dTbuf: 10°C (5-30°C) Const. temp. night: 60°C (20-90°C)
 dTbuf-off: 5°C (3-50°C) Day room temp.: 20°C (5-30°C)
 Night room temp.: 20°C (5-30°C)

Note: the selected temperature of the accumulation tank (buffer) (Tbuf) cannot be higher than the selected temperature of the boiler (Tboiler).

11.12. CONFIGURATION B-0-2

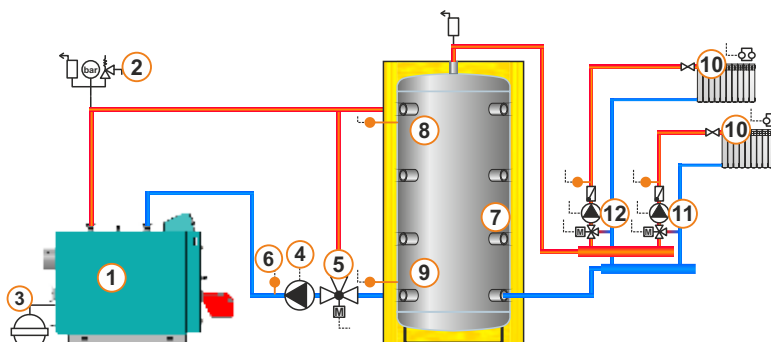
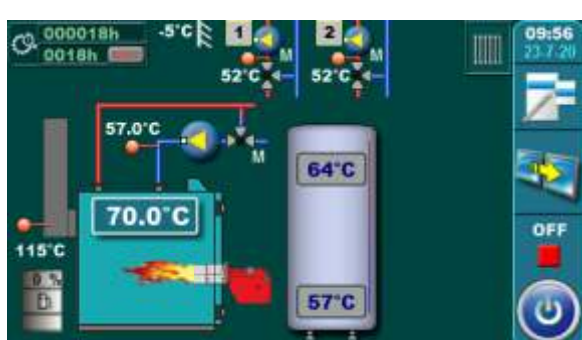

Temperatures: Tboiler: 80°C (80-100°C) Tbuf min.: 20°C (5-85°C)
 Boiler t. Difference: 5°C (5-20°C) 1. Circuit, 2. Circuit:
 Tbuf: 80°C (70-100°C) Const. temp. day: 60°C (20-90°C)
 dTbuf: 10°C (5-30°C) Const. temp. night: 60°C (20-90°C)
 dTbuf-off: 5°C (3-50°C) Day room temp.: 20°C (5-30°C)
 Night room temp.: 20°C (5-30°C)

Note: the selected temperature of the accumulation tank (buffer) (Tbuf) cannot be higher than the selected temperature of the boiler (Tboiler).

11.13. CONFIGURATION B-0-3

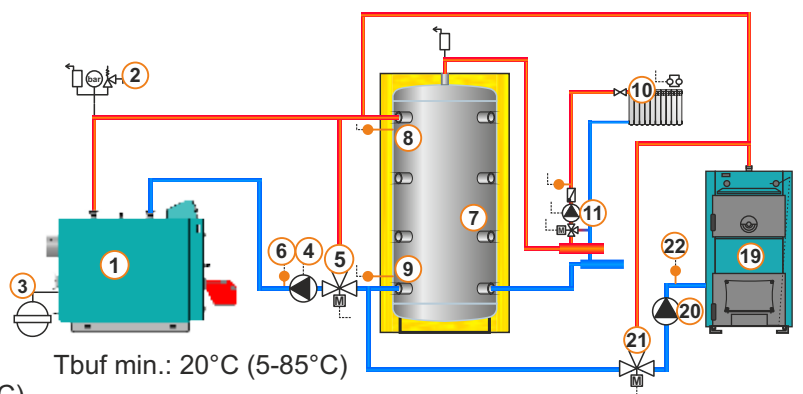
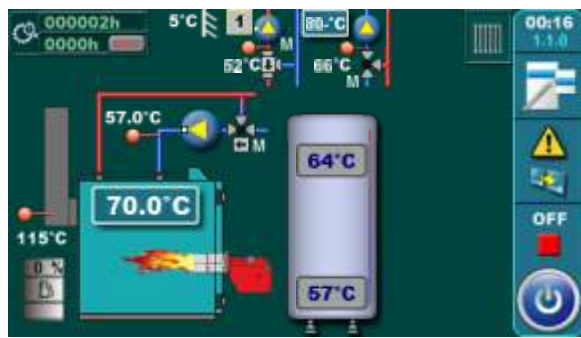

Temperatures: Tboiler: 80°C (80-100°C)
 Boiler t. Difference: 5°C (5-20°C)
 Tbuf: 80°C (70-100°C)
 dTbuf: 10°C (5-30°C)
 dTbuf-off: 5°C (3-50°C)

Tbuf min.: 20°C (5-85°C)
 1. Circuit:
 Const. temp. day: 60°C (20-90°C)
 Const. temp. night: 60°C (20-90°C)
 Day room temp.: 20°C (5-30°C)
 Night room temp.: 20°C (5-30°C)

Note: the selected temperature of the accumulation tank (buffer) (Tbuf) cannot be higher than the selected temperature of the boiler (Tboiler).

11.14. CONFIGURATION B-0-4

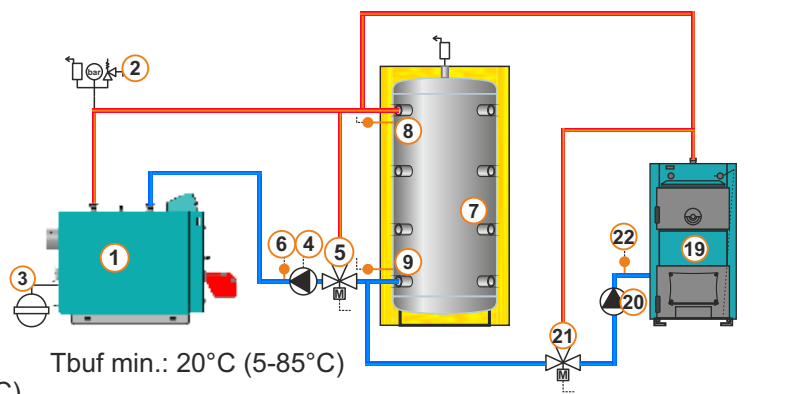
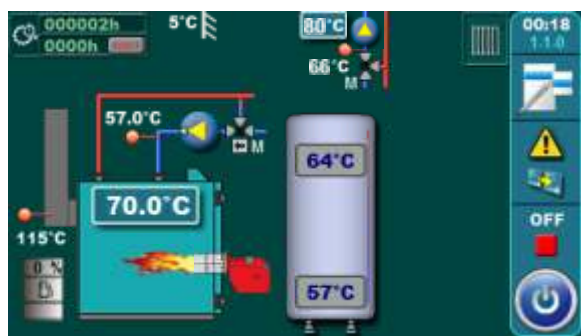

Temperatures: Tboiler: 80°C (80-100°C)
 Boiler t. Difference: 5°C (5-20°C)
 Tbuf: 80°C (70-100°C)
 dTbuf: 10°C (5-30°C)
 dTbuf-off: 5°C (3-50°C)

Tbuf min.: 20°C (5-85°C)

Note: the selected temperature of the accumulation tank (buffer) (Tbuf) cannot be higher than the selected temperature of the boiler (Tboiler).

11.15. CONFIGURATION B-1-0

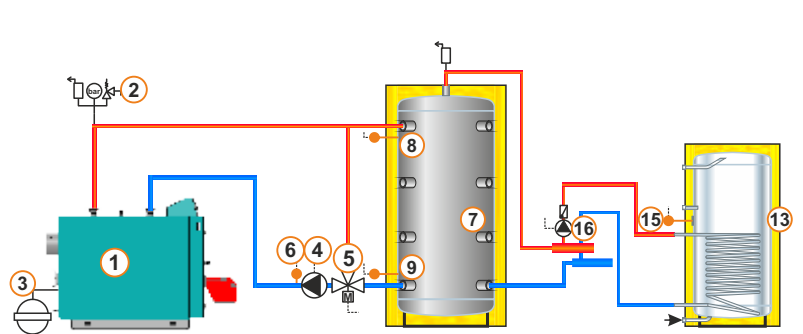
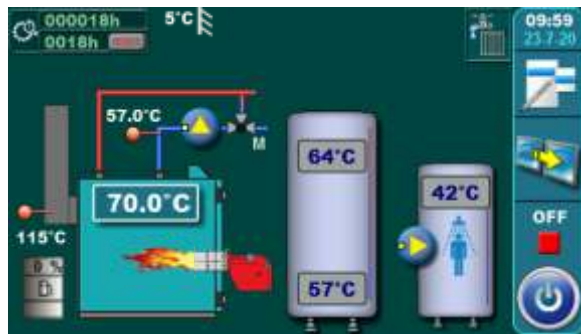

Temperatures: Tboiler: 80°C (80-100°C)
 Boiler t. Difference: 5°C (5-20°C)
 Tbuf: 80°C (70-100°C)
 dTbuf: 10°C (5-30°C)
 dTbuf-off: 5°C (3-50°C)

Tdhw: 50°C (10-70°C)
 dTdhw: 5°C (5-50°C)

Note: the selected temperature of the accumulation tank (buffer) (Tbuf) cannot be higher than the selected temperature of the boiler (Tboiler).

11.16. CONFIGURATION B-2-0

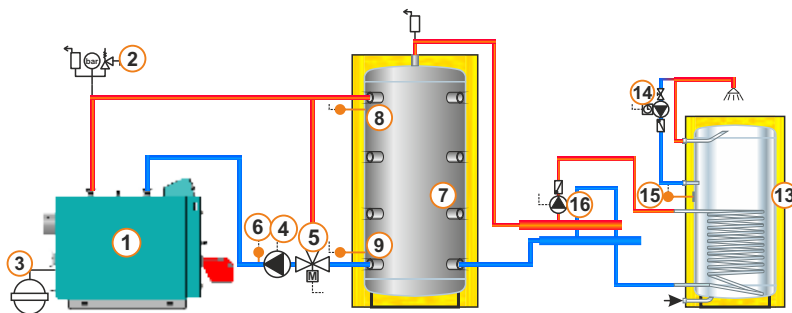
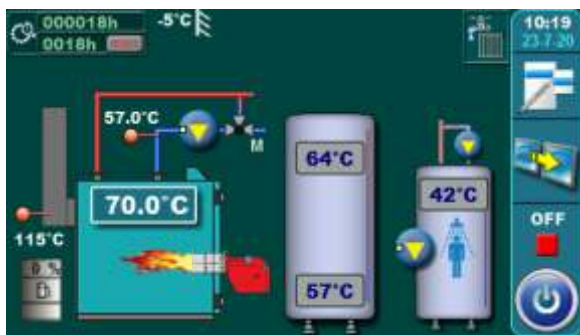

Temperatures: Tboiler: 80°C (80-100°C) Tdhw: 50°C (10-70°C)
 Boiler t. Difference: 5°C (5-20°C) dTdhw: 5°C (5-50°C)
 Tbuf: 80°C (70-100°C) Recirk.-Tmin DHW: 35°C (10-60°C)
 dTbuf: 10°C (5-30°C)
 dTbuf-off: 5°C (3-50°C)

Note: the selected temperature of the accumulation tank (buffer) (Tbuf) cannot be higher than the selected temperature of the boiler (Tboiler).

11.17. CONFIGURATION B-1-1

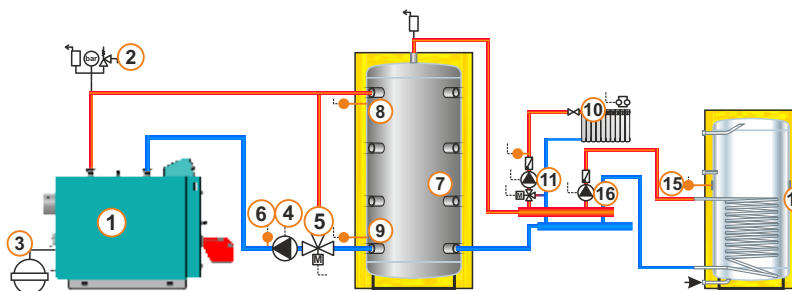
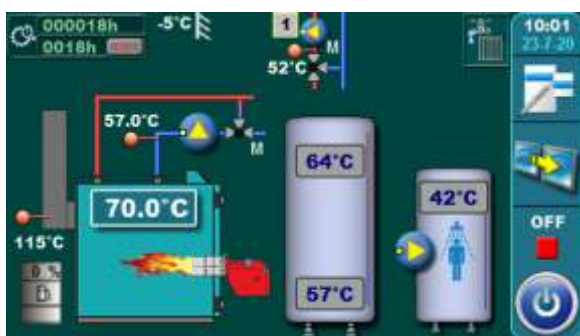

Temperatures: Tboiler: 80°C (80-100°C) Tdhw: 50°C (10-70°C)
 Boiler t. Difference: 5°C (5-20°C) dTdhw: 5°C (5-50°C)
 Tbuf: 80°C (70-100°C) Tbuf min.: 20°C (5-85°C)
 dTbuf: 10°C (5-30°C)
 dTbuf-off: 5°C (3-50°C)

1. Circuit:
 Const. temp. day: 60°C (20-90°C)
 Const. temp. night: 60°C (20-90°C)
 Day room temp.: 20°C (5-30°C)
 Night room temp.: 20°C (5-30°C)

Note: the selected temperature of the accumulation tank (buffer) (Tbuf) cannot be higher than the selected temperature of the boiler (Tboiler).

11.18. CONFIGURATION B-1-2

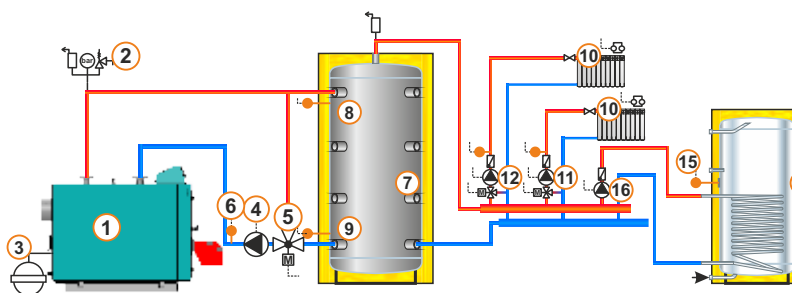
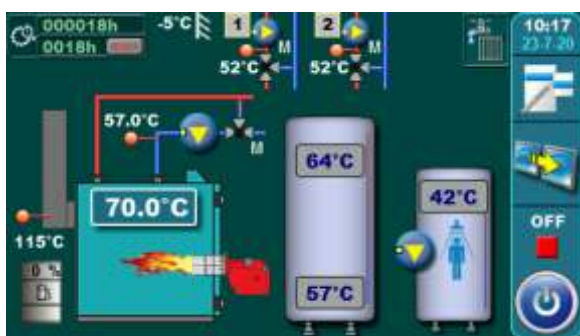

Temperatures: Tboiler: 80°C (80-100°C) Tdhw: 50°C (10-70°C)
 Boiler t. Difference: 5°C (5-20°C) dTdhw: 5°C (5-50°C)
 Tbuf: 80°C (70-100°C) Tbuf min.: 20°C (5-85°C)
 dTbuf: 10°C (5-30°C)
 dTbuf-off: 5°C (3-50°C)

1. Circuit, 2. Circuit:
 Const. temp. day: 60°C (20-90°C)
 Const. temp. night: 60°C (20-90°C)
 Day room temp.: 20°C (5-30°C)
 Night room temp.: 20°C (5-30°C)

Note: the selected temperature of the accumulation tank (buffer) (Tbuf) cannot be higher than the selected temperature of the boiler (Tboiler).

11.19. CONFIGURATION B-1-3

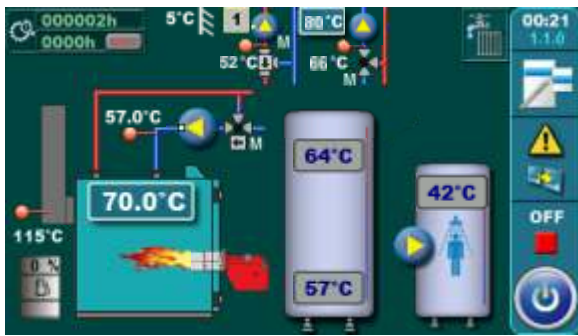

Temperatures:

Tboiler: 80°C (80-100°C)
 Boiler t. Difference: 5°C (5-20°C)
 Tbuf: 80°C (70-100°C)
 dTbuf: 10°C (5-30°C)
 dTbuf-off: 5°C (3-50°C)

Tdhw: 50°C (10-70°C)
 dTdhw: 5°C (5-50°C)
 Tbuf min.: 20°C (5-85°C)

1. Circuit:

Const. temp. day: 60°C (20-90°C)
 Const. temp. night: 60°C (20-90°C)
 Day room temp.: 20°C (5-30°C)
 Night room temp.: 20°C (5-30°C)

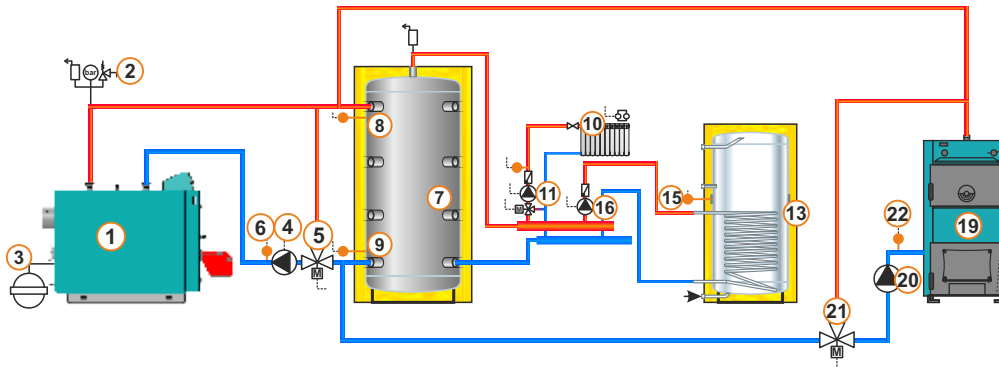

Note: the selected temperature of the accumulation tank (buffer) (Tbuf) cannot be higher than the selected temperature of the boiler (Tboiler).

11.20. CONFIGURATION B-1-4

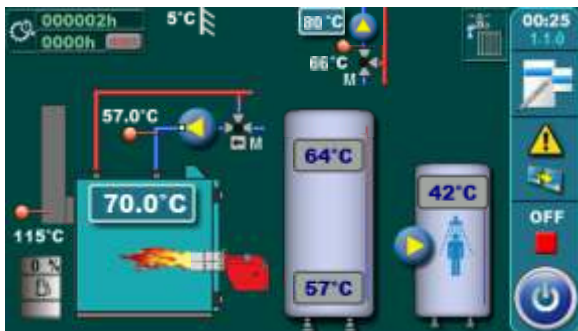

Temperatures:

Tboiler: 80°C (80-100°C)
 Boiler t. Difference: 5°C (5-20°C)
 Tbuf: 80°C (70-100°C)
 dTbuf: 10°C (5-30°C)
 dTbuf-off: 5°C (3-50°C)

Tdhw: 50°C (10-70°C)
 dTdhw: 5°C (5-50°C)
 Tbuf min.: 20°C (5-85°C)

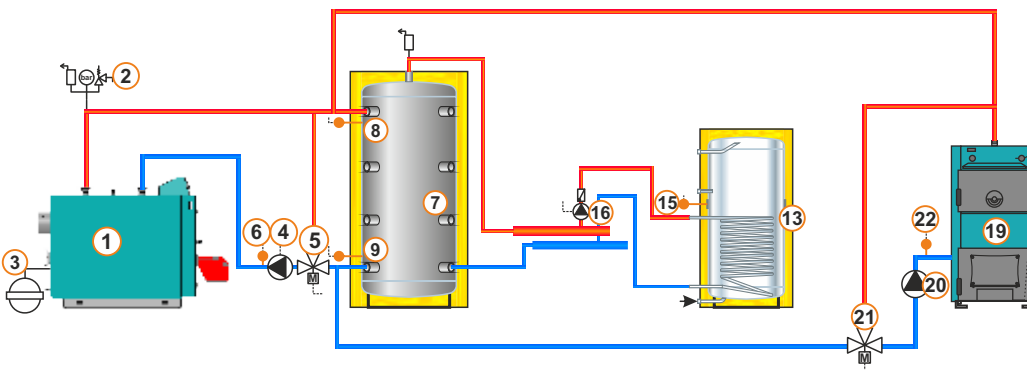

Note: the selected temperature of the accumulation tank (buffer) (Tbuf) cannot be higher than the selected temperature of the boiler (Tboiler).

11.21. CONFIGURATION B-2-1

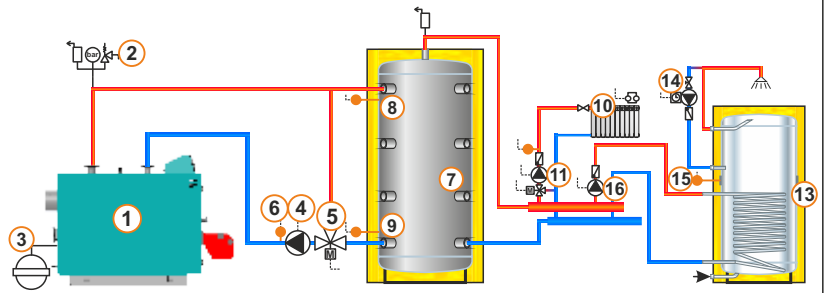
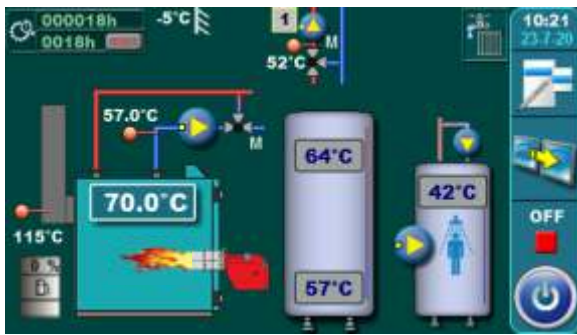

Temperatures: Tboiler: 80°C (80-100°C)
 Boiler t. Difference: 5°C (5-20°C)
 Tbuf: 80°C (70-100°C)
 dTbuf: 10°C (5-30°C)
 dTbuf-off: 5°C (3-50°C)

Tdhw: 50°C (10-70°C)
 dTdhw: 5°C (5-50°C)
 Tbuf min.: 20°C (5-85°C)

1. Circuit:
 Const. temp. day: 60°C (20-90°C)
 Const. temp. night: 60°C (20-90°C)
 Day room temp.: 20°C (5-30°C)
 Night room temp.: 20°C (5-30°C)

Recirk.-Tmin DHW: 35°C (10-60°C)

Note: the selected temperature of the accumulation tank (buffer) (**Tbuf**) cannot be higher than the selected temperature of the boiler (**Tboiler**).

11.22. CONFIGURATION B-2-2

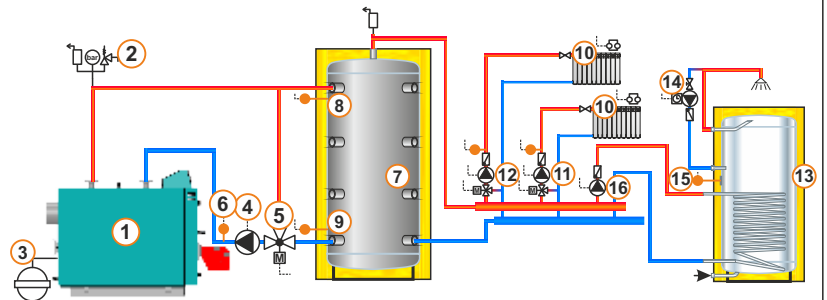
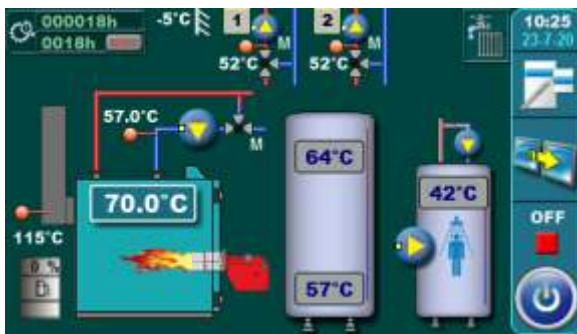

Temperatures: Tboiler: 80°C (80-100°C)
 Boiler t. Difference: 5°C (5-20°C)
 Tbuf: 80°C (70-100°C)
 dTbuf: 10°C (5-30°C)
 dTbuf-off: 5°C (3-50°C)

Tdhw: 50°C (10-70°C)
 dTdhw: 5°C (5-50°C)
 Tbuf min.: 20°C (5-85°C)

1. Circuit, 2. Circuit:
 Const. temp. day: 60°C (20-90°C)
 Const. temp. night: 60°C (20-90°C)
 Day room temp.: 20°C (5-30°C)
 Night room temp.: 20°C (5-30°C)

Recirk.-Tmin DHW: 35°C (10-60°C)

Note: the selected temperature of the accumulation tank (buffer) (**Tbuf**) cannot be higher than the selected temperature of the boiler (**Tboiler**).

11.23. CONFIGURATION B-2-3

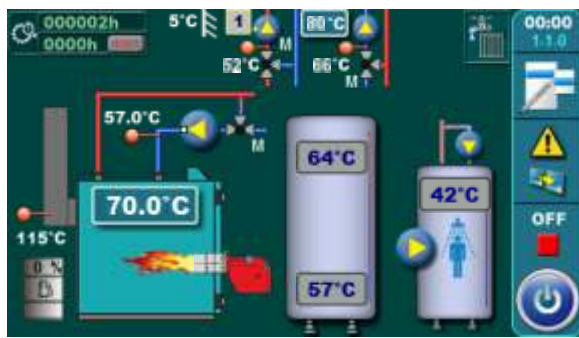

Temperatures:

Tboiler: 80°C (80-100°C)
 Boiler t. Difference: 5°C (5-20°C)
 Tbuf: 80°C (70-100°C)
 dTbuf: 10°C (5-30°C)
 dTbuf-off: 5°C (3-50°C)

Tdhw: 50°C (10-70°C)
 dTdhw: 5°C (5-50°C)
 Tbuf min.: 20°C (5-85°C)
 Recirk.-Tmin DHW: 35°C (10-60°C)

1. Circuit:

Const. temp. day: 60°C (20-90°C)
 Const. temp. night: 60°C (20-90°C)
 Day room temp.: 20°C (5-30°C)
 Night room temp.: 20°C (5-30°C)

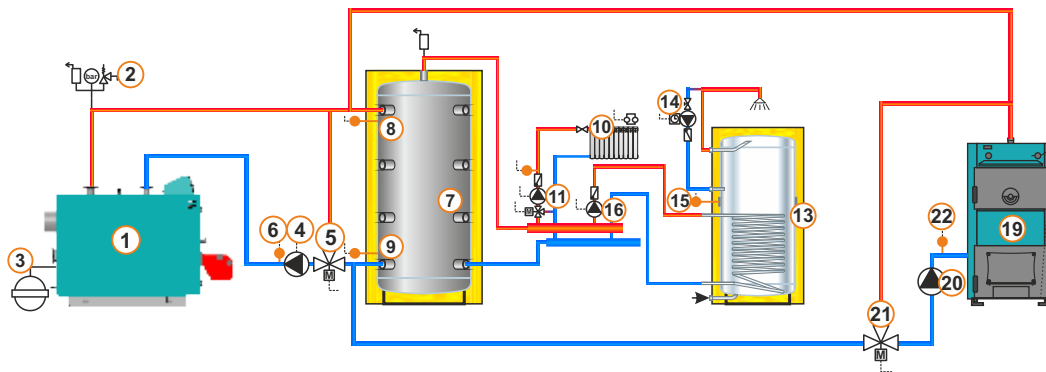

Note: the selected temperature of the accumulation tank (buffer) (Tbuf) cannot be higher than the selected temperature of the boiler (Tboiler).

11.24. CONFIGURATION B-2-4

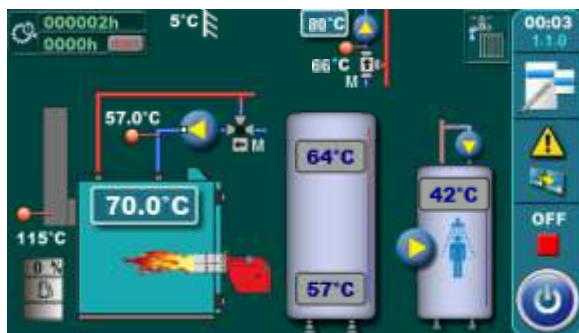

Temperatures:

Tboiler: 80°C (80-100°C)
 Boiler t. Difference: 5°C (5-20°C)
 Tbuf: 80°C (70-100°C)
 dTbuf: 10°C (5-30°C)
 dTbuf-off: 5°C (3-50°C)

Tdhw: 50°C (10-70°C)
 dTdhw: 5°C (5-50°C)
 Tbuf min.: 20°C (5-85°C)
 Recirk.-Tmin DHW: 35°C (10-60°C)

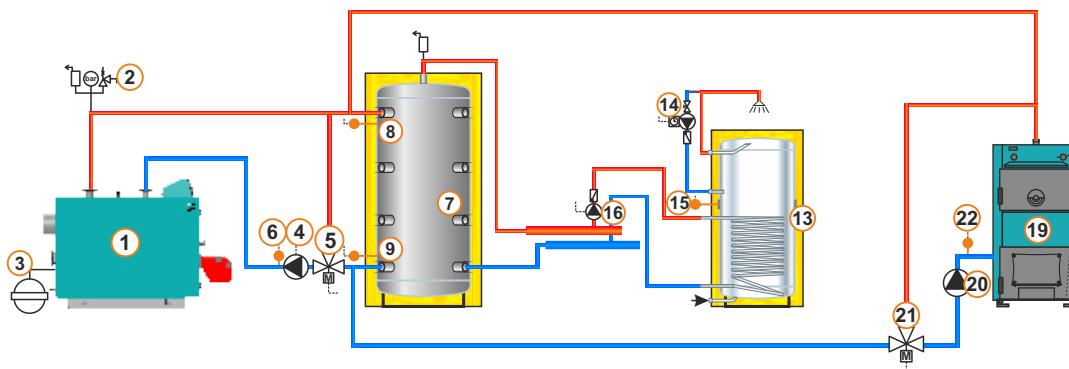

Note: the selected temperature of the accumulation tank (buffer) (Tbuf) cannot be higher than the selected temperature of the boiler (Tboiler).

11.25. CONFIGURATION C-0-0

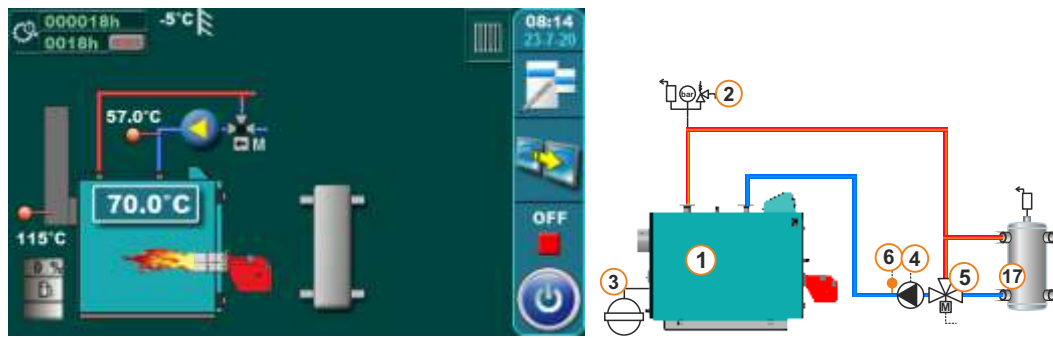

Temperatures: Tboiler: 80°C (70-100°C)
Boiler t. Difference: 5°C (5-20°C)

11.26. CONFIGURATION C-0-1

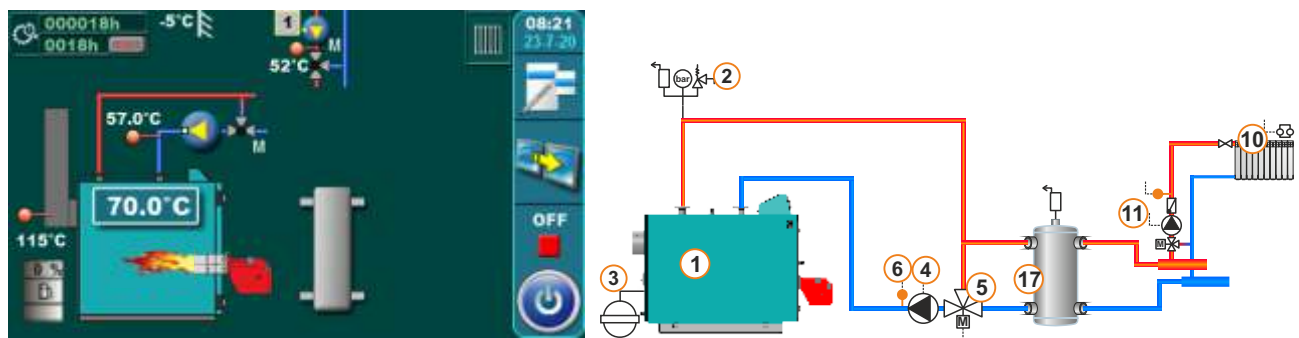

Temperatures: Tboiler: 80°C (70-100°C)
Boiler t. Difference: 5°C (5-20°C)

1. Circuit:
Const. temp. day: 60°C (20-90°C)
Const. temp. night: 60°C (20-90°C)
Day room temp.: 20°C (5-30°C)
Night room temp.: 20°C (5-30°C)

11.27. CONFIGURATION C-0-2

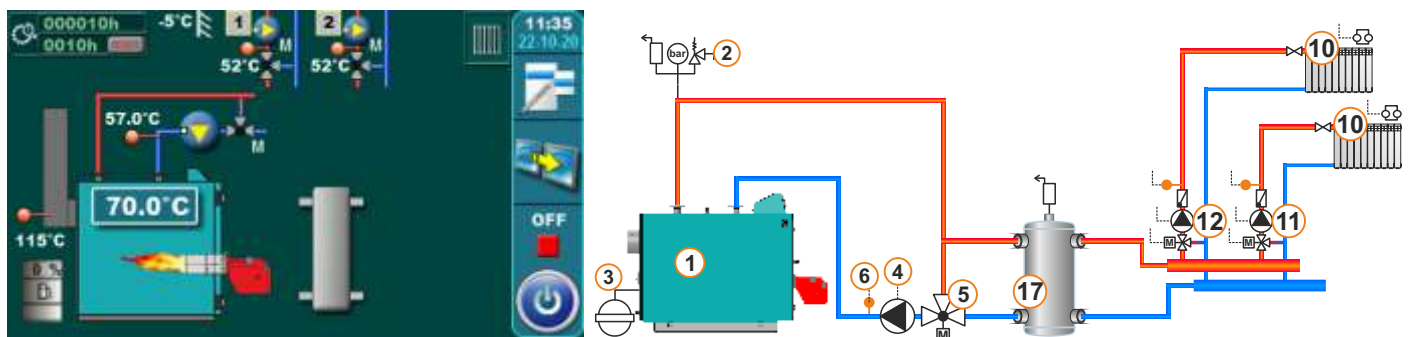

Temperatures: Tboiler: 80°C (70-100°C)
Boiler t. Difference: 5°C (5-20°C)

1. Circuit, 2. Circuit:
Const. temp. day: 60°C (20-90°C)
Const. temp. night: 60°C (20-90°C)
Day room temp.: 20°C (5-30°C)
Night room temp.: 20°C (5-30°C)

11.28. CONFIGURATION C-1-0

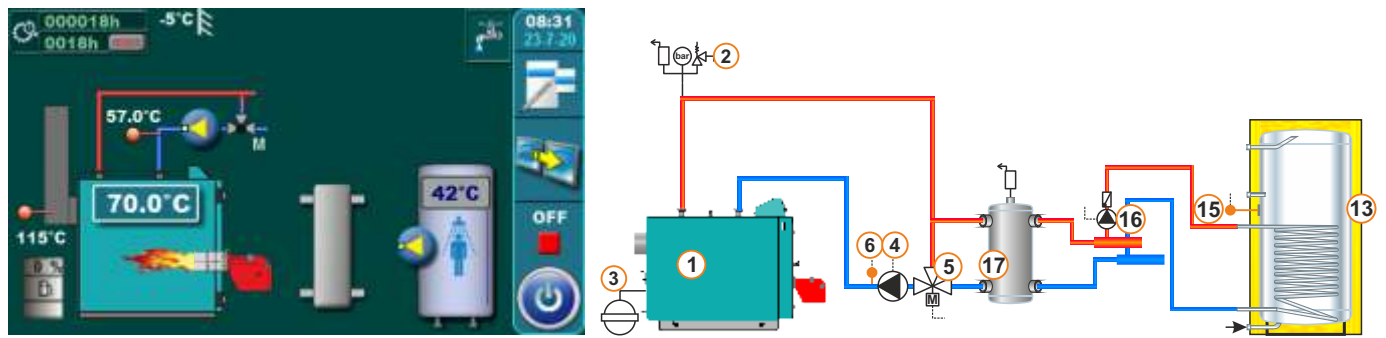

Temperatures: Tboiler: 80°C (70-100°C)
 Boiler t. Difference: 5°C (5-20°C)
 Tdhw: 50°C (10-75°C)
 dTdhw: 5°C (5-50°C)

11.29. CONFIGURATION C-2-0

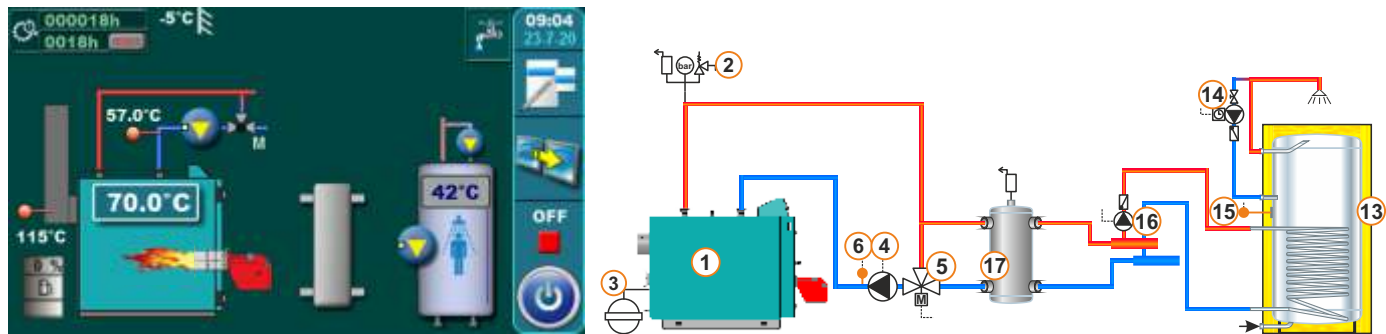

Temperatures: Tboiler: 80°C (70-100°C)
 Boiler t. Difference: 5°C (5-20°C)
 Tdhw: 50°C (10-75°C)
 dTdhw: 5°C (5-50°C)
 Recirk.-Tmin DHW: 35°C (10-60°C)

11.30. CONFIGURATION C-1-1

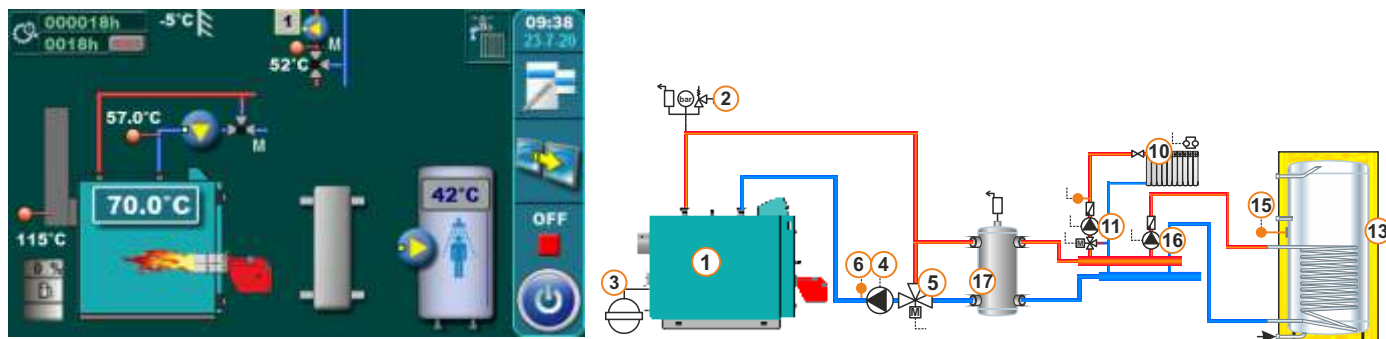

Temperatures: Tboiler: 80°C (70-100°C)
 Boiler t. Difference: 5°C (5-20°C)
 Tdhw: 50°C (10-75°C)
 dTdhw: 5°C (5-50°C)

1. Circuit:
 Const. temp. day: 60°C (20-90°C)
 Const. temp. night: 60°C (20-90°C)
 Day room temp.: 20°C (5-30°C)
 Night room temp.: 20°C (5-30°C)

11.31. CONFIGURATION C-1-2

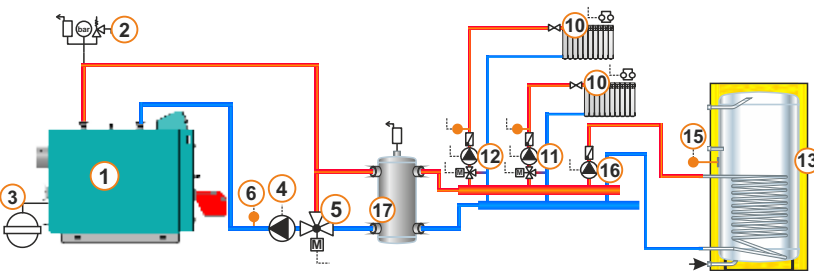
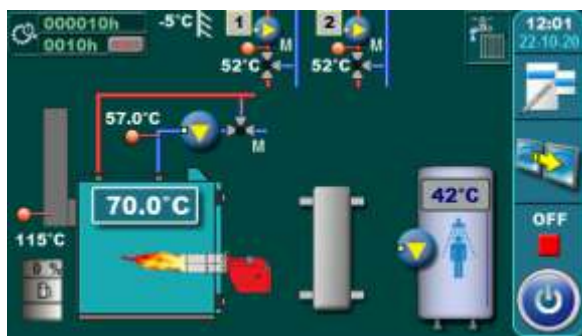

Temperatures: Tboiler: 80°C (70-100°C)
 Boiler t. Difference: 5°C (5-20°C)
 Tdhw: 50°C (10-75°C)
 dTdhw: 5°C (5-50°C)

1. Circuit, 2. Circuit:
 Const. temp. day: 60°C (20-90°C)
 Const. temp. night: 60°C (20-90°C)
 Day room temp.: 20°C (5-30°C)
 Night room temp.: 20°C (5-30°C)

11.32. CONFIGURATION C-2-1

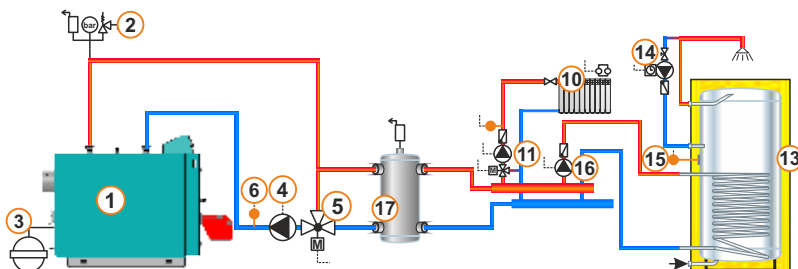
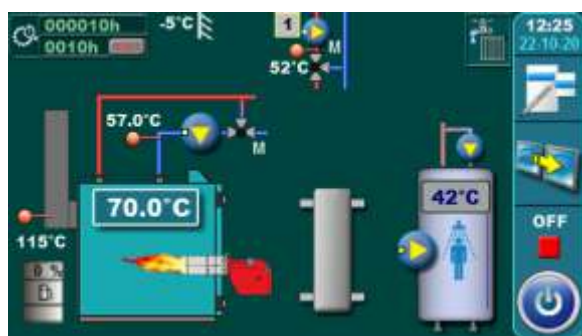

Temperatures:
 Tboiler: 80°C (70-100°C)
 Boiler t. Difference: 5°C (5-20°C)
 Tdhw: 50°C (10-75°C)
 dTdhw: 5°C (5-50°C)

1. Circuit:
 Const. temp. day: 60°C (20-90°C)
 Const. temp. night: 60°C (20-90°C)
 Day room temp.: 20°C (5-30°C)
 Night room temp.: 20°C (5-30°C)

Recirk.-Tmin DHW: 35°C (10-60°C)

11.33. CONFIGURATION C-2-2

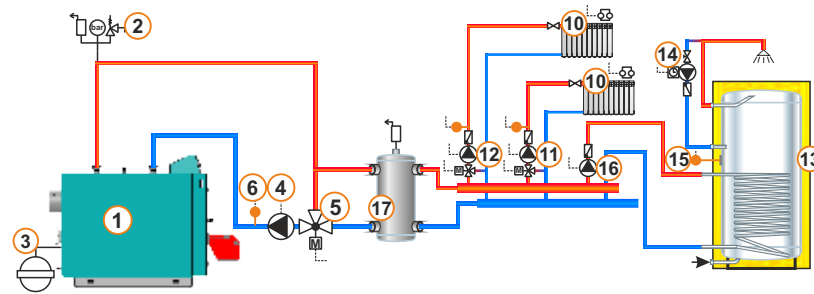
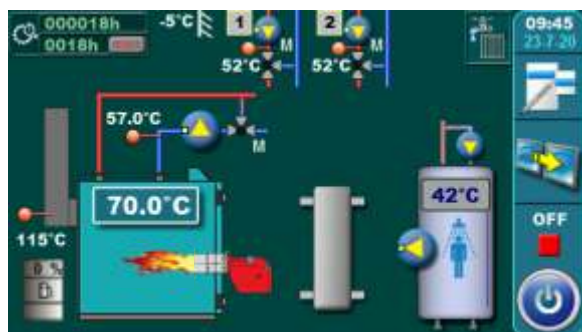

Temperatures:
 Tboiler: 80°C (70-100°C)
 Boiler t. Difference: 5°C (5-20°C)
 Tdhw: 50°C (10-75°C)
 dTdhw: 5°C (5-50°C)

1. Circuit, 2. Circuit:
 Const. temp. day: 60°C (20-90°C)
 Const. temp. night: 60°C (20-90°C)
 Day room temp.: 20°C (5-30°C)
 Night room temp.: 20°C (5-30°C)

Recirk.-Tmin DHW: 35°C (10-60°C)

Legend:

- 1 - Boiler **EKO-CUP SU3, EKO-CUP-S3, EKO-CUP-V3, EKO-CUP SV3 2500**
- 2 - Safety-vent group
- 3 - Closed expansion vessel
- 4 - Boiler pump P1 (**1/6 - PUMPS1**)
- 5 - Return flow protection: - 3-way mixing valve with actuator (**1/6 - BURNER1**)
- 6 - Return flow sensor (**4/6 - TEMP2**)
- 7 - Accumulation tank
- 8 - Upper sensor of the accumulation tank (**4/6 - TEMP1**)
- 9 - Lower sensor of the accumulation tank (**4/6 - TEMP2**)
- 10 - Mixing heating circuit
- 11 - 1. circuit flow sensor (**4/6 - TEMP3**) + heating circuit pump 1 (**1/6 - PUMPS2**) + motor actuator of heating circuit mixing valve 1 (**1/6 - MVAL1**)
- 12 - 2. circuit flow sensor (**4/6 - TEMP3**) + heating circuit pump 2 (**1/6 - PUMPS2**) + motor actuator of heating circuit mixing valve 2 (**1/6 - MVAL2**)
- 13 - DHW tank
- 14 - DHW recirculation (**1/6 - PUMPS1**)
- 15 - DHW tank sensor (**4/6 - TEMP1**)
- 16 - DHW tank pump (**1/6 - PUMPS1**)
- 17 - Hydraulic crossover
- 18 - Hydraulic crossover temperature sensor (**4/6 - TEMP1**)
- 19 - Alternative (manually stoked) boiler/fireplace on biomass
- 20 - Pump (P5) of alternative (manually stoked) boiler/fireplace (**1/6 - PUMPS2**)
- 21 - Motor actuator of return flow safety of alternative (manually stoked) boiler/fireplace (**1/6 - BURNER1**)
- 22 - Alternative (manually stoked) boiler/fireplace return flow sensor (**4/6 - TEMP3**)

12.0 ERRORS AND WARNINGS

12.1 LIST AND TROUBLESHOOTING OF ERRORS

ERROR	NAME	DESCRIPTION
E0	COMMUNICATION ERROR WITH MOTHERBOARD	<p>Possible cause: No communication between the PC board and other parts of the boiler.</p> <p>Boiler status: Currently goes to OFF mode</p> <p>Troubleshooting: Call an authorized serviceman who will check everything</p>
E1	BURNER ALARM	<p>Possible cause: The controller integrated on the burner reported a error in the burner operation, faulty wiring of the burner to the PCB.</p> <p>Boiler status: Currently goes to OFF mode</p> <p>Troubleshooting: Try to fix the the error as described in the technical instructions for burner and if you have not fixed the error, check the wiring from the burner connector B4 to the PCB I3->2 (according to the electrical scheme from the controlller's technical instructions). If you can't fix it, call an authorized burner service technician.</p>
E2	HIGH PRESSURE	<p>Possible cause: departure to shutdown mode.</p> <p>Troubleshooting: Expansion vessel problem, error high pressure sensor.</p>
E3	LOW PRESSURE	<p>Boiler status: departure to shutdown mode.</p> <p>Possible cause: Water leakage from heating system, problem with expansion tank, faulty low pressure sensor.</p>
E4	INCORRECT BOILER SENSOR	<p>Possible cause: Break in the cables between the sensor and control, control contacts, cold connection or defective boiler sensor</p> <p>Boiler status: departure to shutdown mode.</p> <p>Troubleshooting: Call an authorized serviceman to check the sensor location in the tank, check for sensor/cable damage, check connections at the connectors, check the ohmic resist. of the sensor.</p>
E5	INCORRECT DHW SENSOR	<p>Possible cause: Break in the cables between the sensor and control, control contacts, cold connection or defective boiler sensor.</p> <p>Boiler status: departure to shutdown mode. If the user turns off the DHW fault stops and the boiler can start.</p> <p>Troubleshooting: Call an authorized serviceman to check the sensor location in the tank, check for sensor/cable damage, check connections at the connectors, check the ohmic resist. of the sensor.</p>
E7	WRONG DATE AND TIME	<p>Possible cause: Low or fully charged battery. Clock reset at 00:00 and date on 1.1.2000. after switching off or unplugging (or not configured), and at least one switching time (boiler/DHW/recirculation) is switched on. If no switching time is on, this error will not occur, but Warning W2. This burner failure can not be detected by itself, it can only occur if a switch-on time is triggered in the work while we have a W2 warning, in which case the burner goes into the shutdown phase. If any currents, during the burner operation (all stages except "OFF", "ST 0" and "PAUSE" are disconnected, then the current is returned and the E7 is acknowledged, the boiler will perform the necessary actions after power failure and will not start due to mistakes. If the currents are gone when the burner is in the "OFF", "ST 0" and "PAUSE" stages, and then the currents return to the E7, the boiler will not start due to an error.</p> <p>Boiler status: The boiler can operate, if all the switching times are off, otherwise it can not operate. The boiler states under different circumstances are described above „Possible cause“.</p> <p>Troubleshooting: It is necessary to replace the battery (CR1220) on the control panel PC board.</p>

E10	INCORRECT BUFFER TANK SENSOR UP	<p>Possible cause: Interruption in cables between sensors and control, control contacts, cold connection or defective sensor in the accu tank upper part.</p> <p>Boiler status: Departure to the Shutdown phase.</p> <p>Troubleshooting: Call an authorized serviceman to check the sensor location in the tank, check for sensor/cable damage, check connections at the connectors, check the ohmic resist. of the sensor.</p>
E11	INCORRECT BUFFER TANK SENSOR DOWN	<p>Possible cause: Interruption in cables between sensors and control, control contacts, cold connection or defective sensor in the accu tank upper part.</p> <p>Boiler status: Departure to the Shutdown phase.</p> <p>Troubleshooting: Call an authorized serviceman to check the sensor location in the tank, check for sensor/cable damage, check connections at the connectors, check the ohmic resist. of the sensor.</p>
E12	INCORRECT CROSSOVER TEPERATURE SENSOR UP	<p>Possible cause: Interruption in cables between sensors and control, control contacts, cold connection or defective sensor in the accu tank upper part.</p> <p>Boiler status: Departure to the Shutdown phase.</p> <p>Troubleshooting: Call an authorized serviceman to check the sensor location in the tank, check for sensor/cable damage, check connections at the connectors, check the ohmic resist. of the sensor.</p>
E13	INCORRECT RETURN LINE SENSOR	<p>Possible cause: Interruption in cables between sensors and control, control contacts, cold connection or defective sensor.</p> <p>Boiler status: Departure to the Shutdown phase, if the pump P1 is in operation and there is a mixing valve (return protection) it goes to 50% openness.</p> <p>Troubleshooting: Call an authorized serviceman to check the sensor location in the tank, check for sensor/cable damage, check connections at the connectors, check the ohmic resist. of the sensor.</p>
E14	INCORRECT OUTSIDE TEMPERATURE SENSOR	<p>Possible cause: Interruption in the cables between the sensor and control (CM2K), control contacts, cold connection or defective sensor.</p> <p>Boiler status: The boiler operate normally, but all heating circuits which are using external temperature sensor shutdown the pump and the freeze protection condition (if it is switched on) automatically assumes that the outside temperature meets the freeze protection condition (unless the authorized service person has switched off the external temperature requirement).</p> <p>Troubleshooting: Call an authorized serviceman to check the sensor location in the tank, check for sensor/cable damage, check connections at the connectors, check the ohmic resist. of the sensor.</p>
E15	SENSOR 1. CIRCUIT	<p>Possible cause: Termination in cables between the 1st heating circuit and control sensor, control contact, cold connection or defective sensor.</p> <p>Boiler status: The boiler operate normally, the 1st circuit stops to operate, shutdown the pump.</p> <p>Troubleshooting: Call an authorized serviceman to check the sensor location in the tank, check for sensor/cable damage, check connections at the connectors, check the ohmic resist. of the sensor.</p>
E16	CORRECTOR 1. CIRCUIT	<p>Possible cause: Termination in cables between the 1st heating circuit regulator and control, control contact, cold connection or defective corrector.</p> <p>Boiler status: The boiler operate normally, the 1st heating circuit continues to perate as if the corrector is off.</p> <p>Troubleshooting: Call an authorized serviceman to check the sensor location in the tank, check for sensor/cable damage, check connections at the connectors, check the ohmic resist. of the sensor.</p>

E17	SENSOR 2. CIRCUIT	<p>Possible cause: Termination in cables between the 2nd heating circuit and control sensor, control contacts, cold connection or defective sensor.</p> <p>Boiler status: The boiler operate normally, 2 circuit stop to operate,switch off the pump.</p> <p>Troubleshooting: Call an authorized serviceman to check the sensor location in the tank, check for sensor/cable damage, check connections at the connectors, check the ohmic resist. of the sensor.</p>
E18	CORRECTOR 2. CIRCUIT	<p>Possible cause: Termination in the cables between the 2 heating circuit connector and control unit. Control unit contacts, cold connection or defective corrector.</p> <p>Boiler status: The boiler operate normally, the 2nd heating circuit continues to operate as if the converter is off.</p> <p>Troubleshooting: Call an authorized serviceman to check the sensor location in the tank, check for sensor/cable damage, check connections at the connectors, check the ohmic resist. of the sensor.</p>
E20	SAFETY THERMOSTAT	<p>Possible cause: Boiler water temperature too high (above 104 ° C) because the safety thermostat interrupts the burner if the boiler temperature exceeds the specified temperature</p> <p>Boiler status: Currently goes to OFF mode</p> <p>Troubleshooting: If the error is still active, check to see if it is ejected the safety thermostat. Wait for the water temp. in the boiler to be below 70 °C and perform the procedure from "SAFETY THERMOSTAT_Case of boiler operation".</p>
E21	INCORRECT RECIRCULATION SENSOR	<p>Possible cause: Interruption in cables between sensors and control, control contacts, cold connection or defective sensor.</p> <p>Boiler status: boiler operate normally</p> <p>Troubleshooting: Call an authorized serviceman to check the sensor location in the tank, check for sensor/cable damage, check connections at the connectors, check the ohmic resist. of the sensor.</p>
E22	UNKNOWN BOILER MAX. TEMPERATURE!	<p>Possible cause: Problem with "key" to load max. boiler temperature, not placed, not recognized or faulty, there is a cold connection or the key is faulty.</p> <p>Boiler status: Currently goes to OFF mode</p> <p>Troubleshooting: Call an authorized service technician to check damage / correctness of "keys" and connections</p>
E23	WRONG BOILER MAX. TEMPERATURE	<p>Possible cause: Wrong "key" set for loading max. boiler temperature or wrong display - used on another boiler - other max. operating temperatures.</p> <p>Boiler status: Currently goes to OFF mode</p> <p>Troubleshooting: Call an authorized service technician</p>
E24	FLUE GAS SENSOR ERROR	<p>Possible cause: Interruption on el. connections between sensor and CUPREG-Touch controller, connection on CUPREG-Touch, cold connection or invalid flue gas sensor.</p> <p>Boiler status: Boiler goes to OF mode</p> <p>Troubleshooting: Call an authorized serviceman to check the sensor location in the tank, check for sensor/cable damage, check connections at the connectors, check the ohmic resist. of the sensor.</p>
E25	COMMUNICATION WITH OBD-2 ERROR	<p>Possible cause: No communication between the PC board and other parts of the boiler.</p> <p>Boiler status: Boiler goes to OF mode</p> <p>Troubleshooting: Call an authorized serviceman who will check everything</p>
E30	BAD IGNITION ERROR	<p>Possible cause: Burner start failed.</p> <p>Boiler status: phase OFF</p> <p>Troubleshooting:</p>
E31	BAD TURNING OFF ERROR	<p>Possible cause: Failed to turn off the burner.</p> <p>Boiler status: phase OFF</p> <p>Troubleshooting: Call an authorized serviceman</p>

E32	FADE OUT 1. STAGE	Possible cause: Boiler status: phase OFF Troubleshooting:
E33	2. STAGE WAS NOT ENGAGED	Possible cause: Boiler status: Troubleshooting:
E34	FADE OUT 2. STAGE	Possible cause: Boiler status: Troubleshooting:
E35	BAD BURNER TURNING OFF 2. STAGE	Possible cause: Boiler status: Troubleshooting:
E100_1	COMMUNICATION ERROR WITH CM2K (1+&2+)	Possible cause: Defective UTP cable or connections on the controller's PCB boards and CM2K. Boiler status: The boiler operates normally. Troubleshooting: Call an authorized serviceman who will check all.
E100_2	COMMUNICATION ERROR WITH CM2K (3+&4+)	Possible cause: Defective UTP cable or connections on the CM2K controller's PCB boards. Boiler status: The boiler operates normally Troubleshooting: Call an authorized serviceman who will check all.
E100_3	COMMUNICATION ERROR WITH CM2K (5+&6+)	Possible cause: Defective UTP cable or connections on the CM2K controller's PCB boards. Boiler status: The boiler operates normally. Troubleshooting: Call an authorized serviceman who will check all.
E100_5	COMMUNICATION ERROR WITH CMGSM	Possible cause: Defective UTP cable or connections on the controller's PCB boards and CMGSM. Boiler status: The boiler operates normally. Troubleshooting: Call an authorized serviceman who will check all.
E100_6	COMMUNICATION ERROR WITH CM WIFI MODULE	Possible cause: Defective UTP cable or connections on the controller's PCB boards and WiFi box. Boiler status: The boiler operates normally Troubleshooting: Call an authorized serviceman who will check all.
E100_7	COMMUNICATION ERROR WITH CMNET	Possible cause: Defective UTP cable or connections on the controller's PCB boards and CMNET. Boiler status: The boiler operates normally as an individual boiler (does not operate in a cascade). Troubleshooting: Call an authorized serviceman who will check all.
E101	SENSOR CM2K 1+ CIRCUIT	Possible cause: Interruption in the cables between the 1st circuit sensor and CM2K, connections on the CM2K, cold junction or defective sensor. Boiler status: The boiler operates normally, the 1st CM2K circuit stops to operate , stops (turns off) the pump. Troubleshooting: Call an authorized serviceman to check the sensor location in the tank, check for sensor/cable damage, check connections at the connectors, check the ohmic resist. of the sensor.
E102	CORRECTOR CM2K 1+ CIRCUIT	Possible cause: Interruption in the cables between the 1st circuit corrector and CM2K, connections on the CM2K , cold junction or defective corrector. Boiler status: The boiler operates normally, the 1st CM2K circuit continues to operate as if the corrector is turned off. Troubleshooting: Call an authorized serviceman to check the sensor location in the tank, check for sensor/cable damage, check connections at the connectors, check the ohmic resist. of the sensor.

<p>E103</p>	<p>SENSOR CM2K 2+ CIRCUIT</p>	<p>Possible cause: Interruption in the cables between the 2nd circuit sensor and CM2K, connections on the CM2K, cold junction or defective sensor. Boiler status: The boiler operates normally, the 2nd CM2K circuit stops to operate, stops (turns off) the pump. Troubleshooting: Call an authorized serviceman to check the sensor location in the tank, check for sensor/cable damage, check connections at the connectors, check the ohmic resist. of the sensor.</p>
<p>E104</p>	<p>CORRECTOR CM2K 2+ CIRCUIT</p>	<p>Possible cause: Interruption in the cables between the 2nd circuit corrector and CM2K, connections on the CM2K, cold junction or defective corrector. Boiler status: The boiler operates normally, the 2nd CM2K circuit continues to operate as if the corrector is turned off. Troubleshooting: Call an authorized serviceman to check the sensor location in the tank, check for sensor/cable damage, check connections at the connectors, check the ohmic resist. of the sensor.</p>
<p>E105</p>	<p>SENSOR CM2K 3+ CIRCUIT</p>	<p>Possible cause: Interruption in the cables between the 3rd circuit sensor and CM2K, connections on the CM2K, cold junction or defective sensor Boiler status: The boiler operates normally, the 3rd CM2K circuit stops to operate, stops (turns off) the pump. Troubleshooting: Call an authorized serviceman to check the sensor location in the tank, check for sensor/cable damage, check connections at the connectors, check the ohmic resist. of the sensor.</p>
<p>E106</p>	<p>CORRECTOR CM2K 3+ CIRCUIT</p>	<p>Possible cause: Interruption in the cables between the 3rd circuit corrector and CM2K, connections on the CM2K, cold junction or defective corrector. Boiler status: The boiler operates normally, the 3rd CM2K circuit continues to operate as if the corrector is turned off. Troubleshooting: Call an authorized serviceman who will check the corrector position, check the damage/accuracy of the corrector and cable, check the contacts on the connectors.</p>
<p>E107</p>	<p>SENSOR CM2K 4+ CIRCUIT</p>	<p>Possible cause: Interruption in the cables between the 4th circuit sensor and CM2K, connections on the CM2K, cold junction or defective sensor. Boiler status: The boiler operates normally, the 4th CM2K circuit stops to operate, stops (turns off) the pump. Troubleshooting: Call an authorized serviceman who will check the corrector position, check the damage/accuracy of the corrector and cable, check the contacts on the connectors.</p>
<p>E108</p>	<p>CORRECTOR CM2K 4+ CIRCUIT</p>	<p>Possible cause: Interruption in the cables between the 4th circuit corrector and CM2K, connections on the CM2K, cold junction or defective corrector Boiler status: The boiler operates normally, the 4th CM2K circuit continues to operate as if the corrector is turned off. Troubleshooting: Call an authorized serviceman who will check the corrector position, check the damage/accuracy of the corrector and cable, check the contacts on the connectors.</p>

E109	SENSOR CM2K 5+ CIRCUIT	<p>Possible cause: Interruption in the cables between the 5th circuit sensor and CM2K, connections on the CM2K, cold junction or defective sensor</p> <p>Boiler status: The boiler operates normally, the 5th CM2K circuit stops to operate, stops (turns off) the pump.</p> <p>Troubleshooting: Call an authorized serviceman to check the sensor location in the tank, check for sensor/cable damage, check connections at the connectors, check the ohmic resist. of the sensor.</p>
E110	CORRECTOR CM2K 5+ CIRCUIT	<p>Possible cause: Interruption in the cables between the 5th circuit corrector and CM2K, connections on the CM2K, cold junction or defective corrector.</p> <p>Boiler status: The boiler operates normally, the 5th CM2K circuit continues to operate as if the corrector is turned off.</p> <p>Troubleshooting: Call an authorized serviceman who will check the corrector position, check the damage/accuracy of the corrector and cable, check the contacts on the connectors.</p>
E111	SENSOR CM2K 6+ CIRCUIT	<p>Possible cause: Interruption in the cables between the 6th circuit sensor and CM2K, connections on the CM2K, cold junction or defective sensor.</p> <p>Boiler status: The boiler operates normally, the 6th CM2K circuit stops to operate, stops (turns off) the pump.</p> <p>Troubleshooting: Call an authorized serviceman who will check the corrector position, check the damage/accuracy of the corrector and cable, check the contacts on the connectors.</p>
E112	CORRECTOR CM2K 6+ CIRCUIT	<p>Possible cause: Interruption in the cables between the 6th circuit corrector and CM2K, connections on the CM2K, cold junction or defective corrector</p> <p>Boiler status: The boiler operates normally, the 6th CM2K circuit continues to operate as if the corrector is turned off.</p> <p>Troubleshooting: Call an authorized serviceman who will check the corrector position, check the damage/accuracy of the corrector and cable, check the contacts on the connectors.</p>
E113	DEFECTIVE SENSOR OF ALTERNATIVE (HAND-HEATED) BOILER / FIREPLACE	<p>Possible cause: Interruption in the cables between the sensor and the boiler, a connection to the boiler, cold junction or defective sensor.</p> <p>Boiler status: With the appearance of E113, the P5 pump works continuously (the motor actuator of the mixing valve in the P5 pump circuit will operate according to its own scheme, maintaining Treturn-min).</p> <p>Troubleshooting: Call an authorized serviceman who will check the corrector position, check the damage/accuracy of the corrector and cable, check the contacts on the connectors.</p>
E114	DEFECTIVE WATER RETURN SENSOR OF ALTERNATIVE (MANUALLY HEATED) BOILER/FIREPLACE	<p>Possible cause: Interruption in the cables between the sensor and the boiler, a connection to the boiler, cold junction or defective sensor.</p> <p>Boiler status: With the appearance of E114, the motor actuator of the mixing valve in the P5 pump circuit when the P5 pump is running does not maintain the Treturn-min but opens 100%.</p> <p>Troubleshooting: Call an authorized serviceman who will check the corrector position, check the damage/accuracy of the corrector and cable, check the contacts on the connectors.</p>

12.2 LIST AND TROUBLESHOOTING OF WARNINGS

W1	FACTORY SETTING LOADED	<p>Possible cause: It occurs when the controller automatically loads the factory parameters as the data in the data base is faulty/incorrect. Under normal circumstances the warning occurs during the first start after changing the software</p> <p>Boiler status: The boiler does not operate and it cannot continue to operate.</p> <p>What needs to be done: Call an authorized serviceman</p>
W2	WRONG DATE AND TIME	<p>Possible cause: The hour resets to 00:00 and the date to 1.1.2000. after switching off the controller on the main switch or due to power outage.</p> <p>Boiler status: The boiler can operate, if it does not use any schedule.</p> <p>What needs to be done: It is necessary to change the battery on the controller screen (CR 1220), set the date and hour on the controller.</p>
W3	LOW RETURN TEMPERATURE	<p>Possible cause: Problem with the mixing valve/actuator (safety of the return), return sensor.</p> <p>Boiler status: The boiler will continue to operate normally</p> <p>What needs to be done: The cause needs to be removed as with a longer operation the boiler will condense and the flue gas passages will be blocked.</p>
W4	LEVEL OF OIL FOR BURNING	<p>Possible cause: Low fuel oil level in the tank.</p> <p>Boiler status: The boiler goes to phase OFF which means there is not enough fuel to continue working.</p> <p>What needs to be done: Fill the tank with oil.</p>
IW1-1	POWER DOWN	<p>Possible cause: Power outage or switching off the controller on the main switch (0/1) unrelated in which operation phase the burner is in, including also the phase OFF.</p> <p>Boiler status: The information is written in the warning history and is not announced on the screen. The record time is the moment of the power outage/switching off the controller on the main switch.</p>
IW1-2	POWER UP	<p>Possible cause: Return of power or switching on the controller on the main switch (0/1).</p> <p>Boiler status: The information is written in the warning history and is not announced on the screen. The record time is the moment of the power return/switching on the controller on the main switch.</p>

13.0 MALFUNCTION / IMPROPER BOILER OPERATION

13.1 SAFETY THERMOSTAT - boiler malfunction

On the boiler controller screen following error is announced (E 20 SAFETY THERMOSTAT), the boiler behaves itself according to the description of the error E20. the cause of this error is a reached to high water temperature in the boiler (above 104°C) as the safety thermostat interrupts the burner fan operation if the temperature in the boiler exceeds the specified temperature.

For a reactivation of the safety thermostat (STB) following needs to be done:

- Wait until the boiler temperature falls below 70°C.
- Unscrew and take off the safety thermostat lid (detail A).
- Press the thermostat restart button (detail B).
- After pressing the thermostat restart button the fan error will be removed/eliminated, the boiler is ready for operation.
- In case the same problem occurs again during the first next boiler firing or if it occurs frequently, ask an advise from the authorized servicemen.

Picture - Safety thermostat

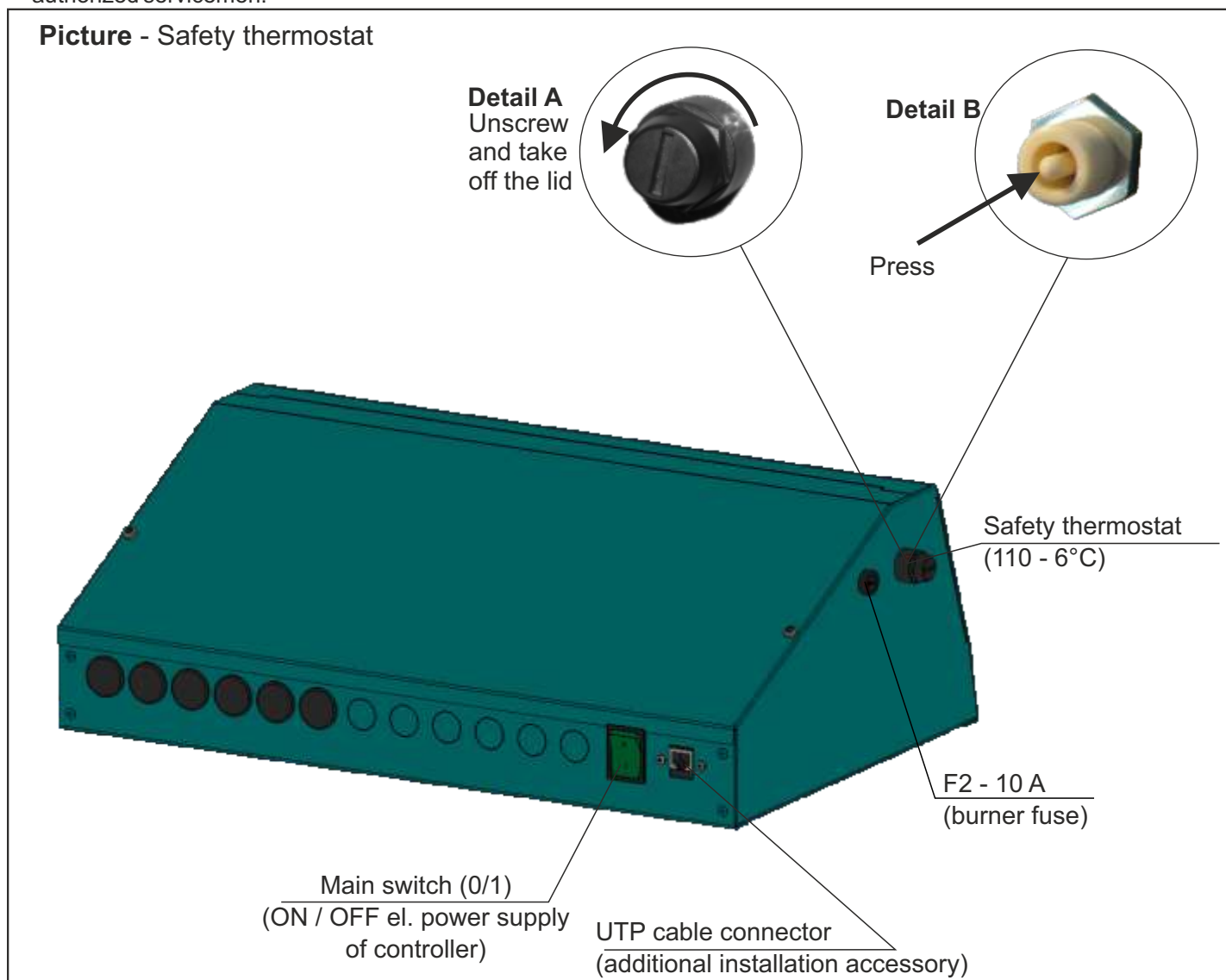

CAUTION!

If the thermostat frequently shuts down the fan please call an authorized serviceman to check the system.

14. ELECTRICAL SCHEME

14.1. EL. SCHEME - ALTERNATIVE (MANUALLY STOKED) BOILER/FIREPLACE NOT CONFIGURED

14.1.1. ELECTRICAL SCHEME 1/6

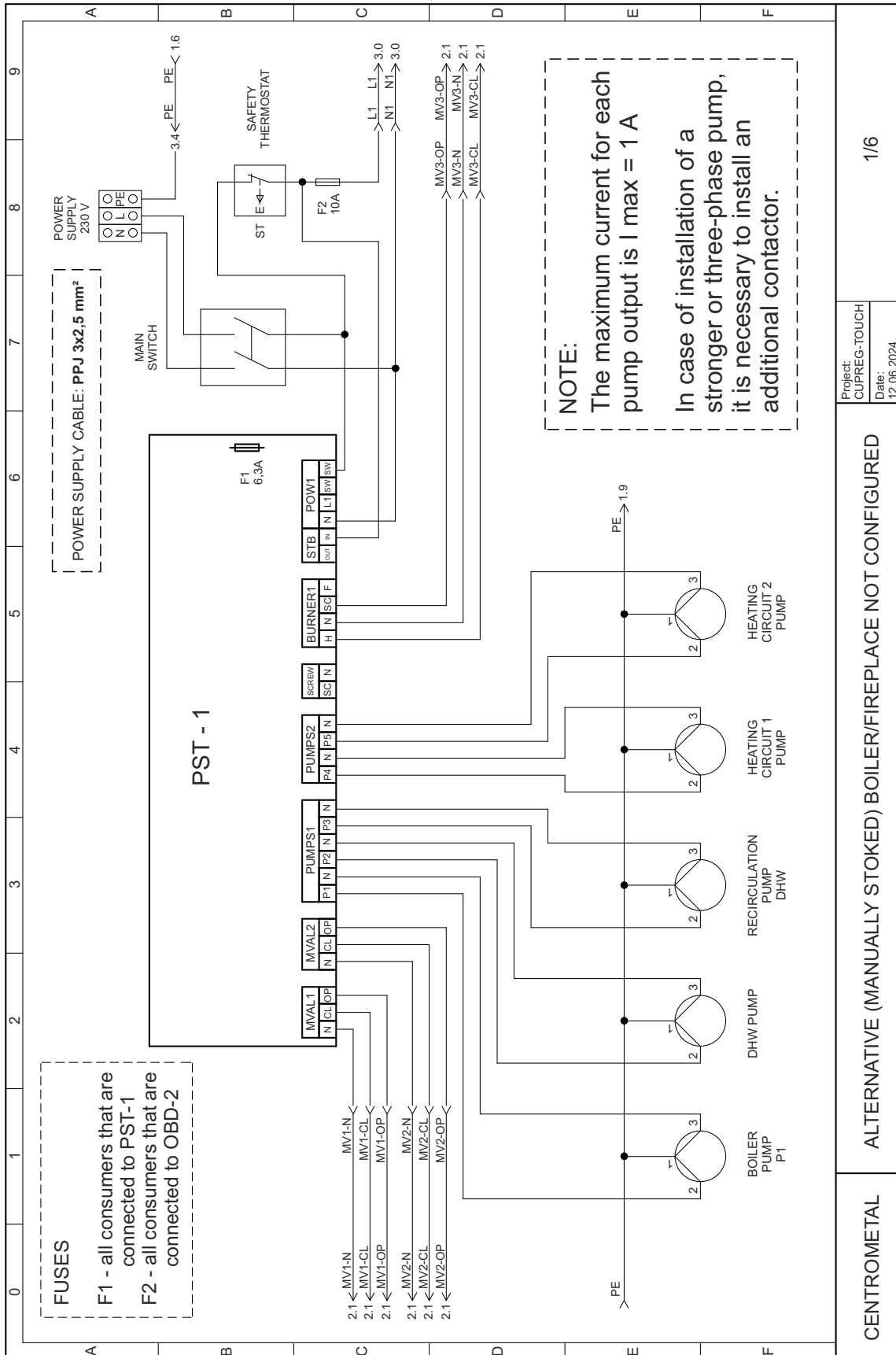

14.1.2. ELECTRICAL SCHEME 2/6

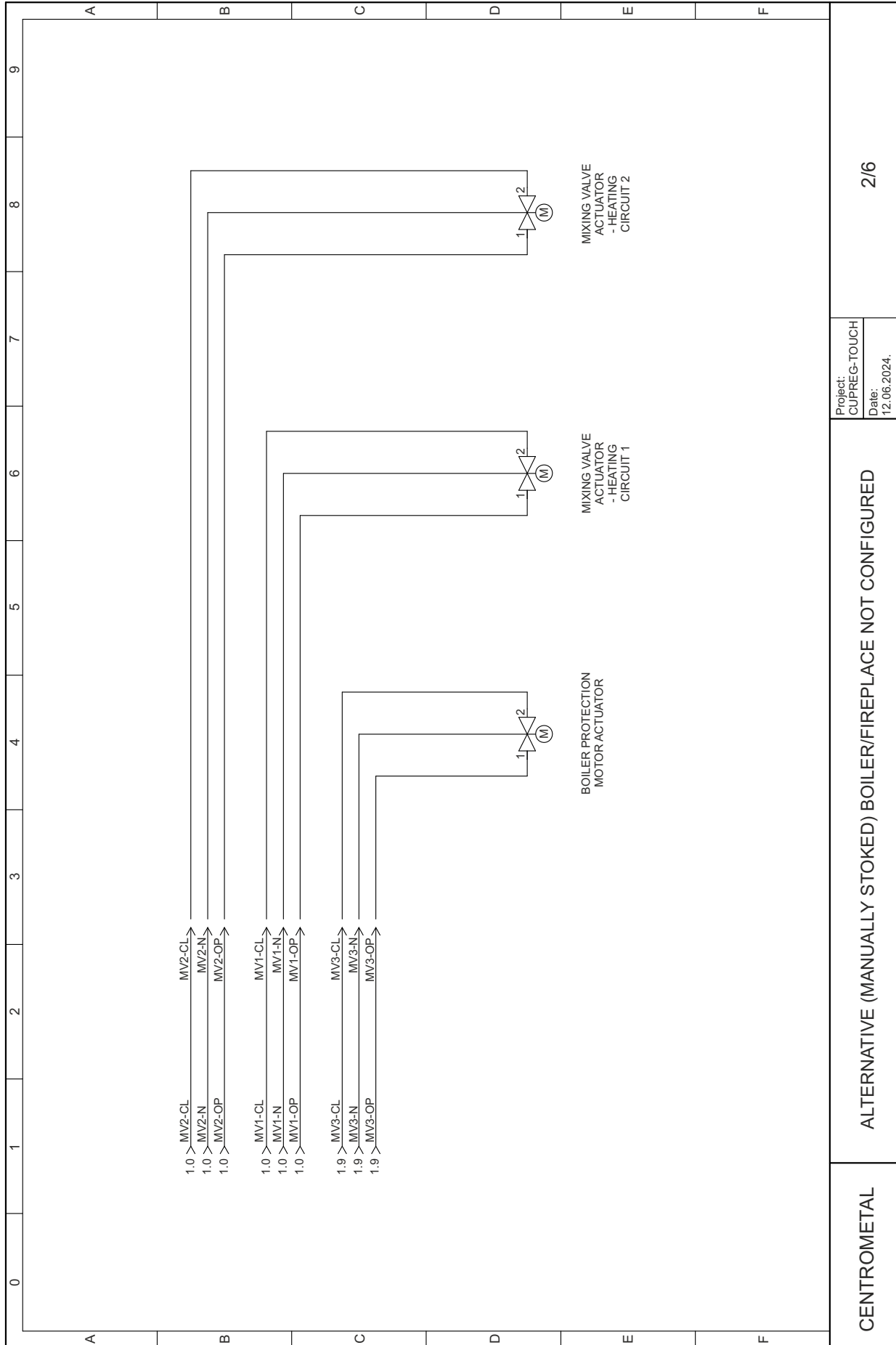

Project:
CUPREG-TOUCH
Date:
12.06.2024.

2/6

ALTERNATIVE (MANUALLY STOKED) BOILER/FIREPLACE NOT CONFIGURED

CENTROMETAL

14.1.3. ELECTRICAL SCHEME 3/6

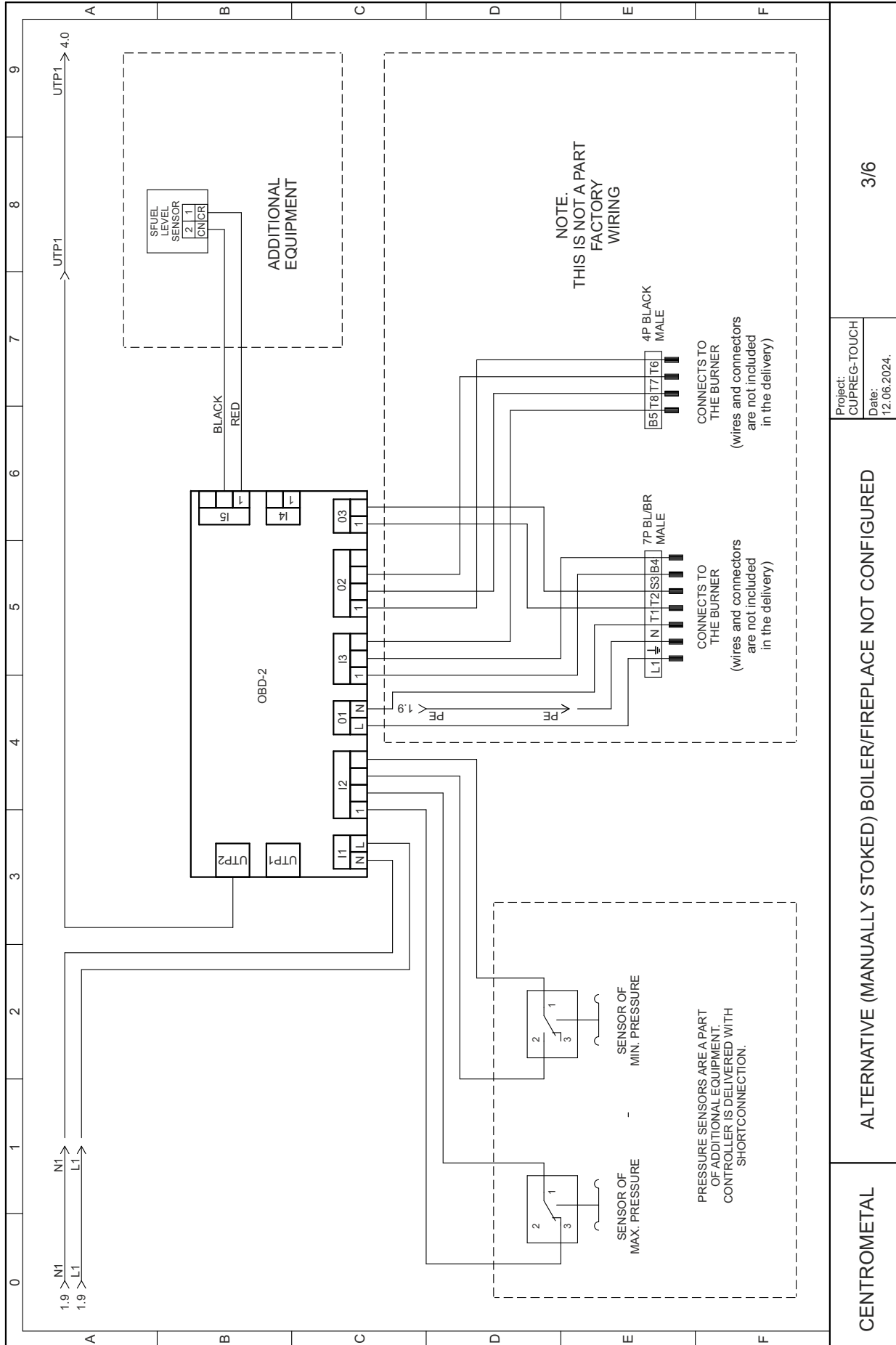

CENTROMETAL	ALTERNATIVE (MANUALLY STOKED) BOILER/FIREPLACE NOT CONFIGURED	Project: CUPREG-TOUCH	3/6
		Date: 12.06.2024.	

14.1.4. ELECTRICAL SCHEME 4/6

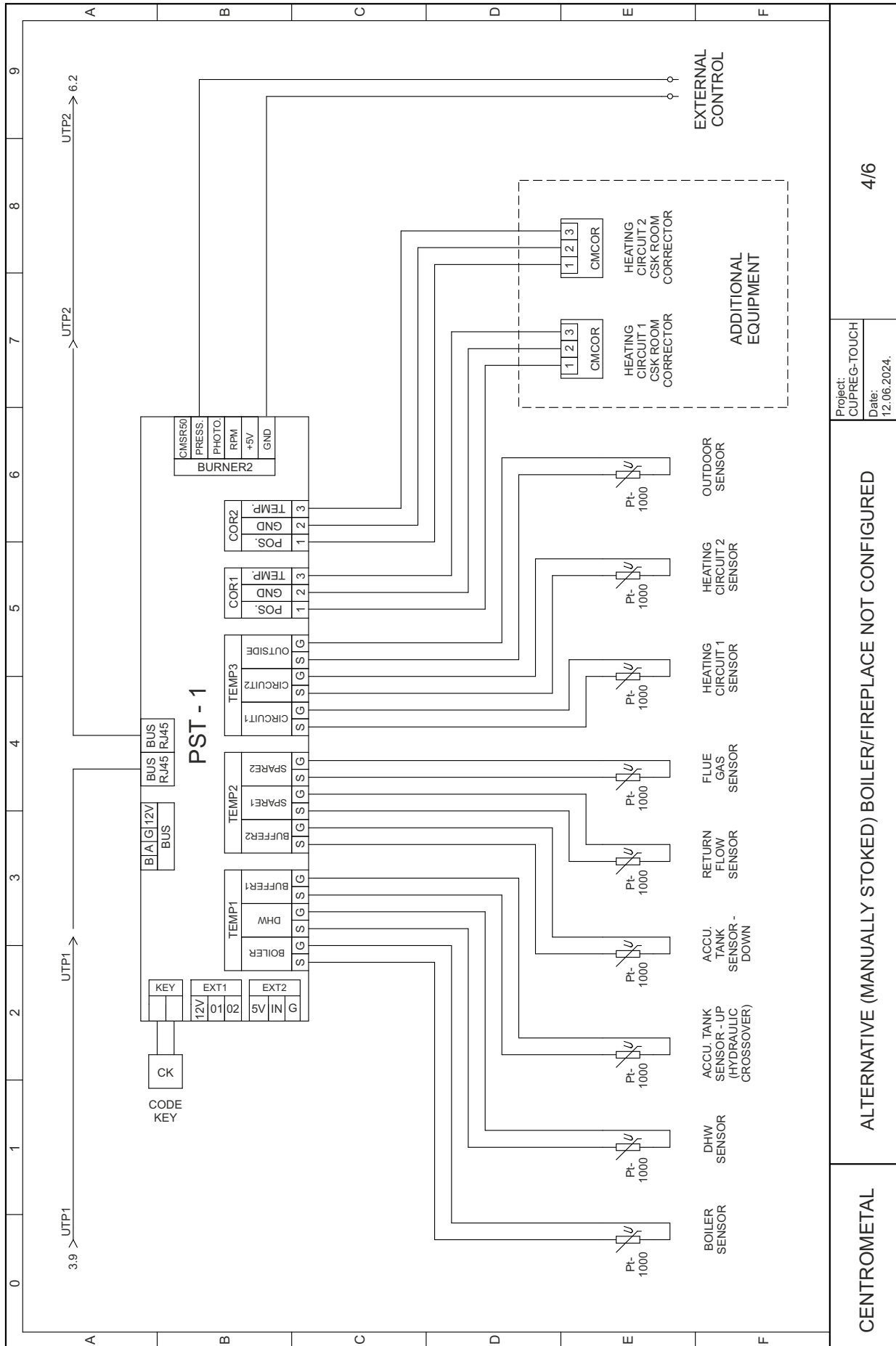

Project: CUPREG-TOUCH
Date: 12.06.2024.

ALTERNATIVE (MANUALLY STOKED) BOILER/FIREPLACE NOT CONFIGURED

CENTROMETAL

4/6

14.1.6. ELECTRICAL SCHEME 6/6

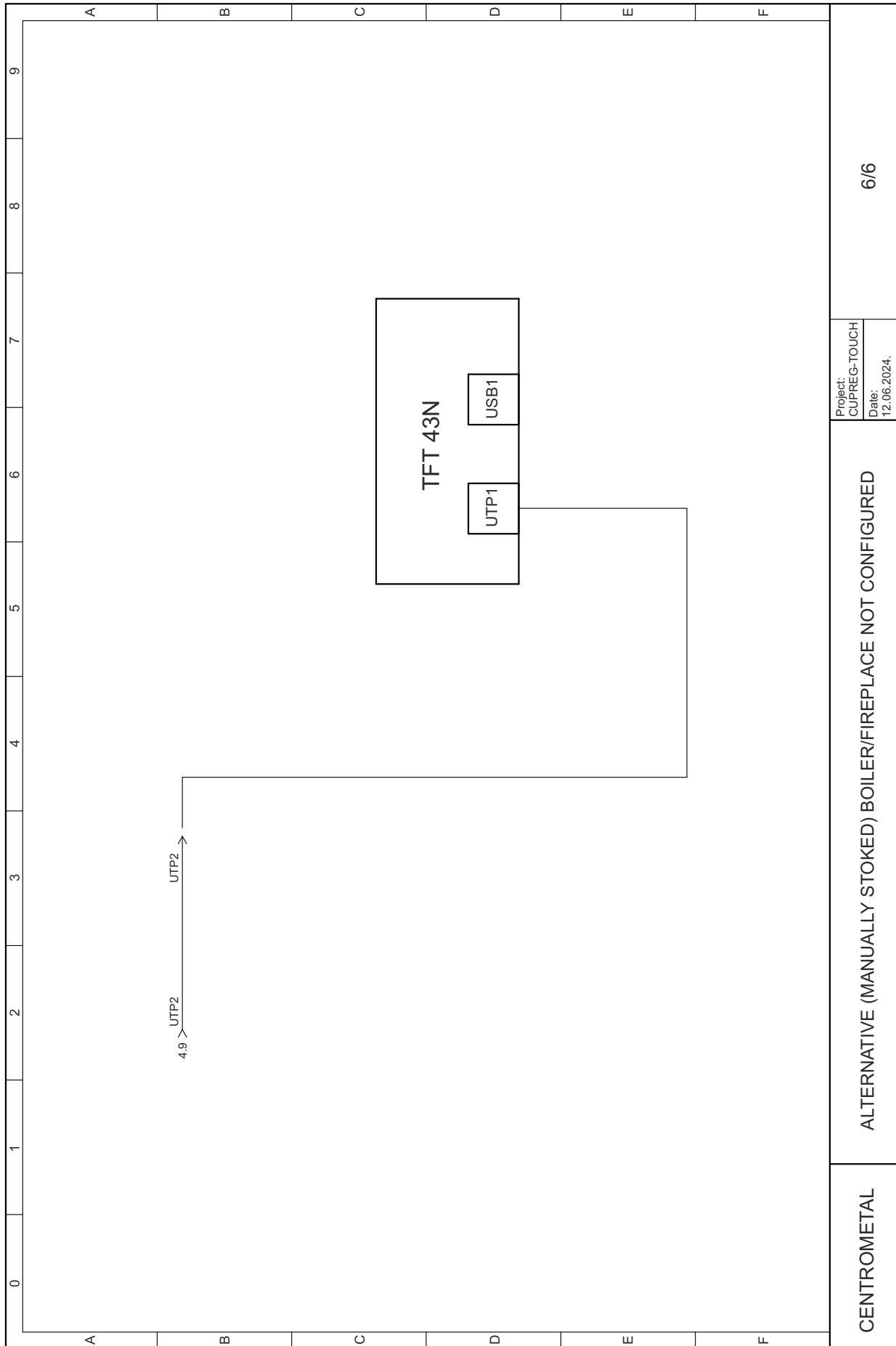

14.2. EL. SCHEME - ALTERNATIVE (MANUALLY STOKED) BOILER/FIREPLACE CONFIGURED

14.2.1. ELECTRICAL SCHEME 1/6

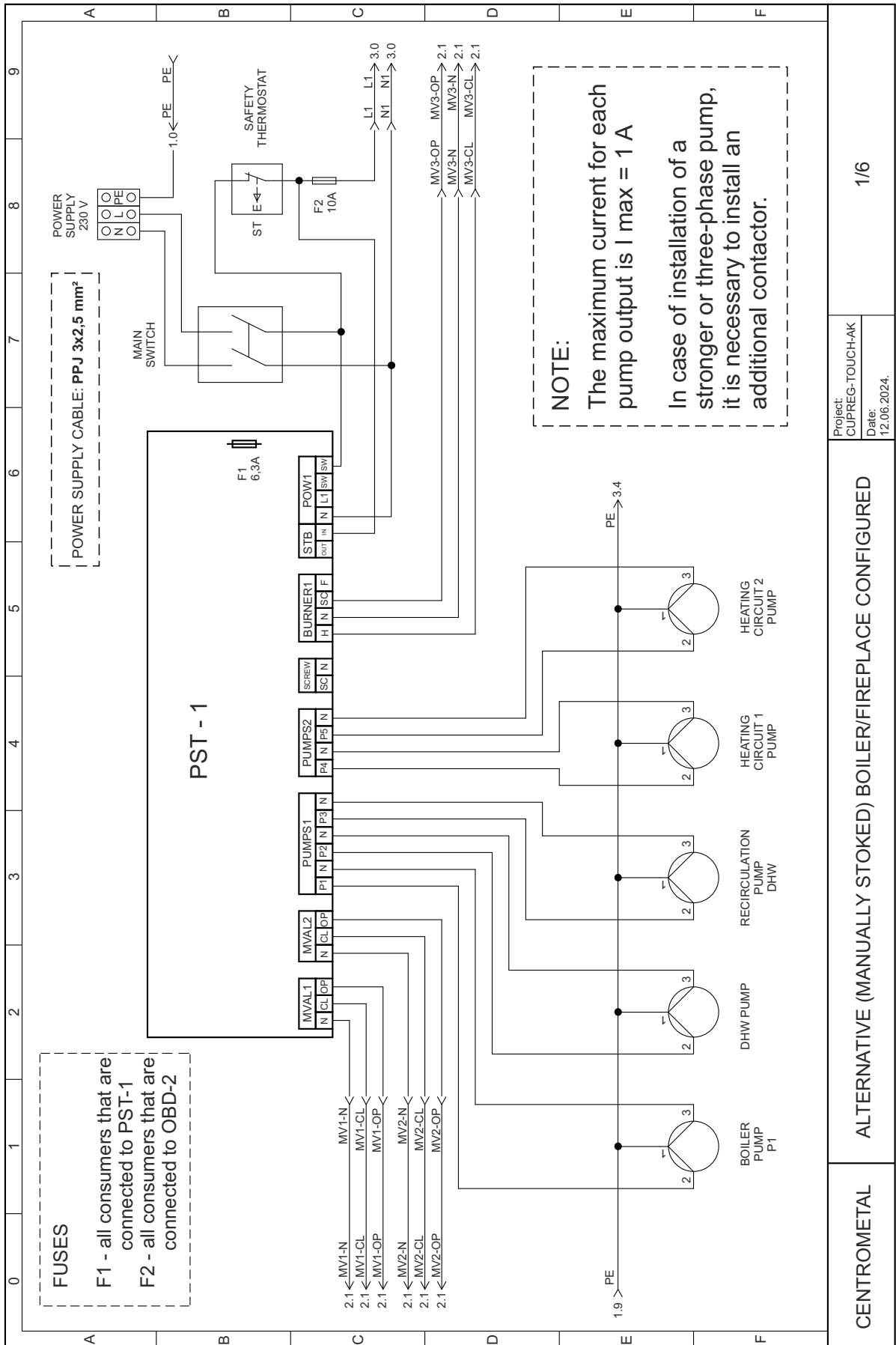

1/6

ALTERNATIVE (MANUALLY STOKED) BOILER/FIREPLACE CONFIGURED

CENTROMETAL

14.2.2. ELECTRICAL SCHEME 2/6

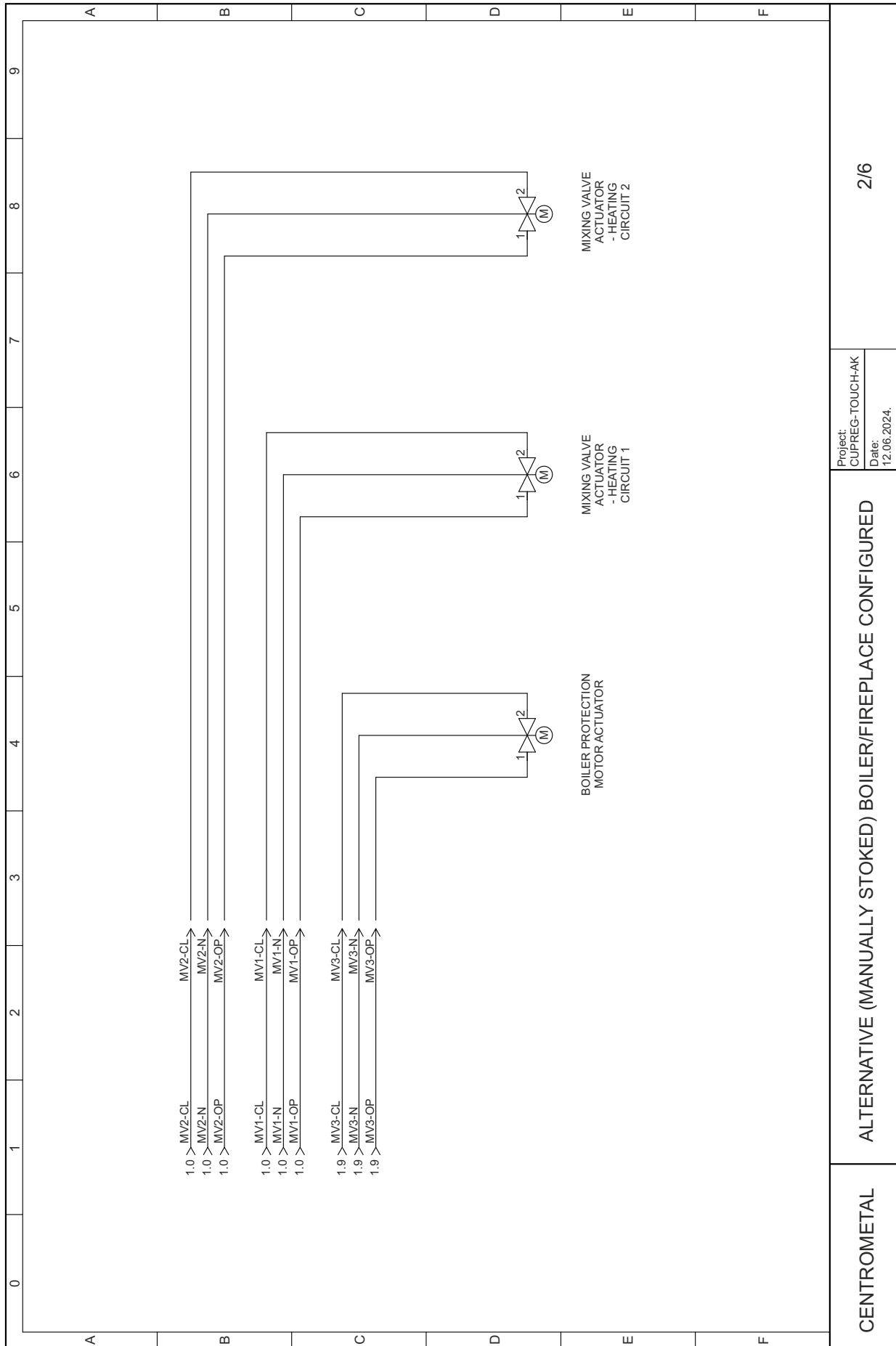

Project:
CUPREG-TOUCH-AK
Date:
12.06.2024.

2/6

ALTERNATIVE (MANUALLY STOKED) BOILER/FIREPLACE CONFIGURED

CENTROMETAL

14.2.3. ELECTRICAL SCHEME 3/6

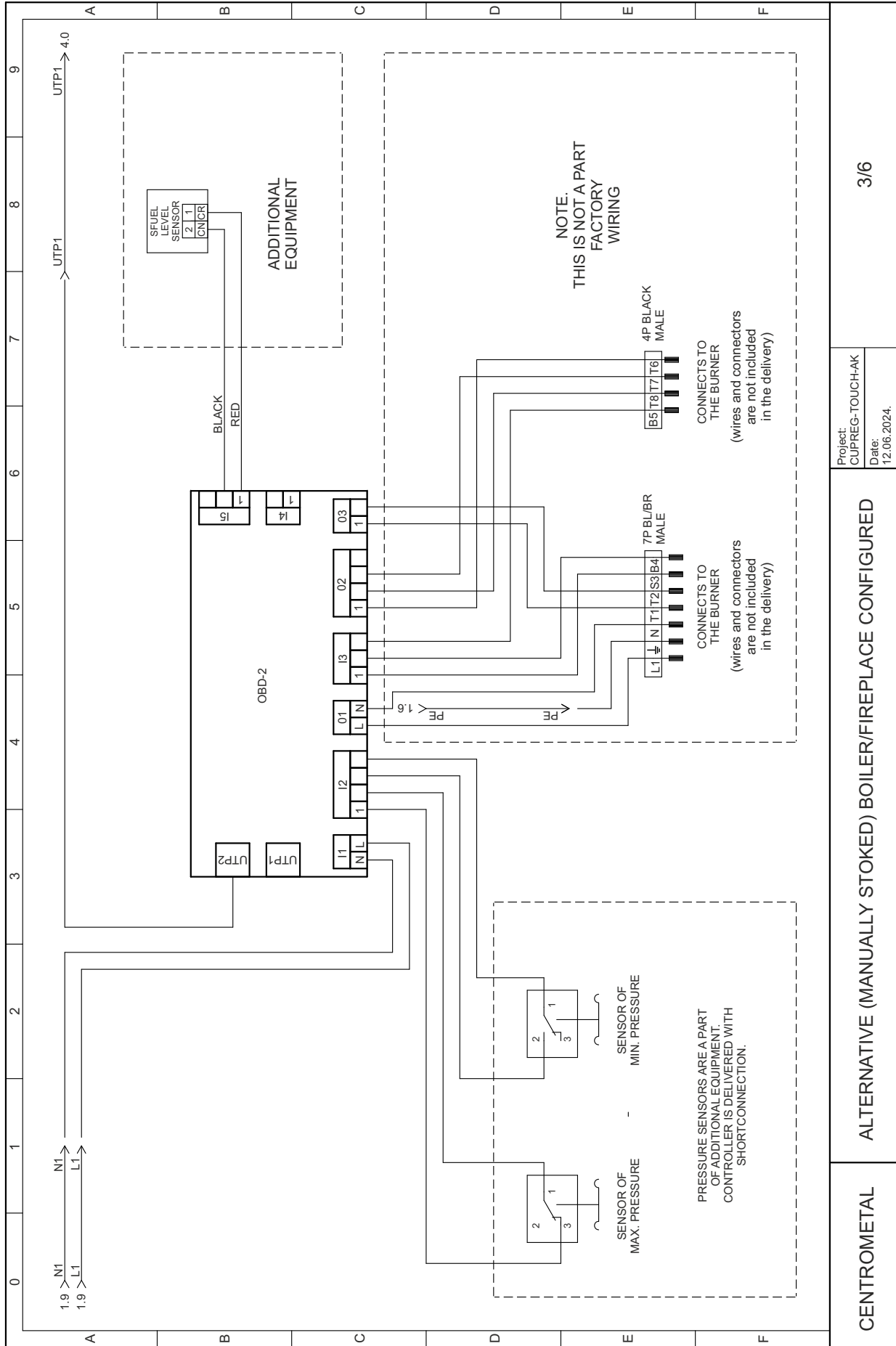

CENTROMETAL	ALTERNATIVE (MANUALLY STOKED) BOILER/FIREPLACE CONFIGURED	3/6
	Project: CUPREG-TOUCH-AK Date: 12.06.2024.	

14.2.5. ELECTRICAL SCHEME 5/6

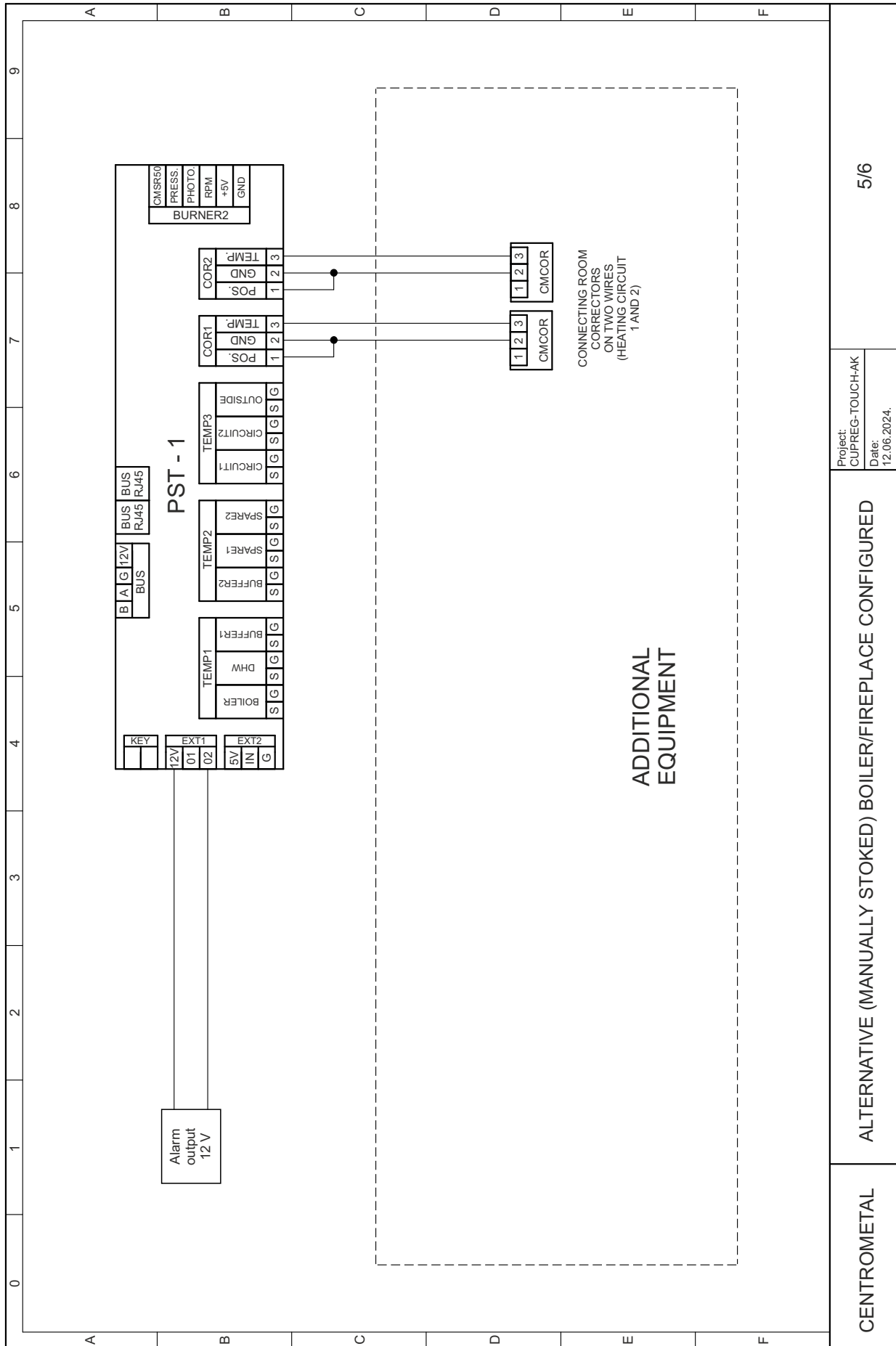

Project: CUPREG-TOUCH-AK
Date: 12.06.2024.

ALTERNATIVE (MANUALLY STOKED) BOILER/FIREPLACE CONFIGURED

CENTROMETAL

14.2.6. ELECTRICAL SCHEME 6/6

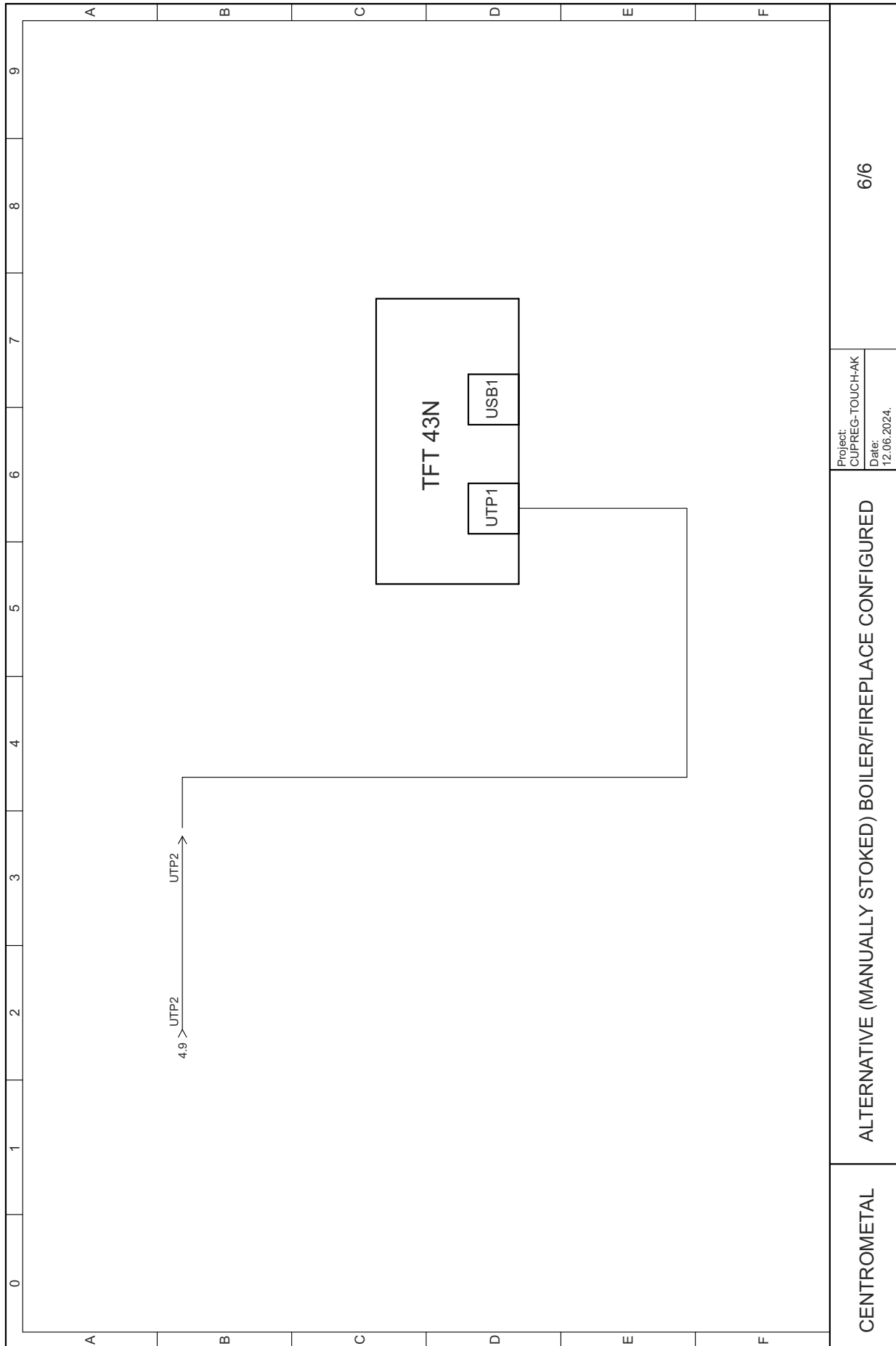

Project:
CUPREG-TOUCH-AK
Date:
12.06.2024.

ALTERNATIVE (MANUALLY STOKED) BOILER/FIREPLACE CONFIGURED

CENTROMETAL

6/6

TABLE WITH RESISTANCE **Pt1000** SENSOR
(range -30 do +400°C)

Temp. (°C)	Resist. (W)	Temp (°C)	Resist. (W)
-30	885	190	1.732
-25	904	195	1.751
-20	923	200	1.770
-15	942	205	1.789
-10	962	210	1.809
-5	981	215	1.828
0	1.000	220	1.847
5	1.019	225	1.866
10	1.039	230	1.886
15	1.058	235	1.905
20	1.077	240	1.924
25	1.096	245	1.943
30	1.116	250	1.963
35	1.135	255	1.982
40	1.154	260	2.001
45	1.173	265	2.020
50	1.193	270	2.040
55	1.212	275	2.059
60	1.231	280	2.078
65	1.250	285	2.097
70	1.270	290	2.117
75	1.289	295	2.136
80	1.308	300	2.155
85	1.327	305	2.174
90	1.347	310	2.194
95	1.366	315	2.213
100	1.385	320	2.233
105	1.404	325	2.251
110	1.424	330	2.271
115	1.443	335	2.290
120	1.462	340	2.309
125	1.481	345	2.328
130	1.501	350	2.348
135	1.520	355	2.367
140	1.539	360	2.386
145	1.558	365	2.405
150	1.578	370	2.425
155	1.597	375	2.444
160	1.161	380	2.463
165	1.635	385	2.482
170	1.655	390	2.502
175	1.674	395	2.521
180	1.693	400	2.540
185	1.712		

TABLE WITH RESISTANCE
NTC 5k/25°C SENSOR
(range -20 do +130°C)

Temperature (°C)	Resist. (W)
-20	48.535
-15	36.465
-10	27.665
-5	21.158
0	16.325
5	12.694
10	9.950
15	7.854
20	6.245
25	5.000
30	4.028
35	3.266
40	2.663
45	2.184
50	1.801
55	1.493
60	1.244
65	1.041
70	876,0
75	740,7
80	629,0
85	536,2
90	458,8
95	394,3
100	340,0
105	294,3
110	255,6
115	222,7
120	190,7
125	170,8
130	150,5



EC IZJAVA O SUKLADNOSTI EC DECLARATION OF CONFORMITY

Proizvođač
Manufacturer: Centrometal d.o.o.
Naziv i adresa
Name and address: HR-40306 Macinec, Glavna 12, Croatia

Punom odgovornošću izjavljuje, da
We declare under our sole responsibility that

Proizvod
Product designation: Toplovodni kotao za loženje ekstra lakim loživim uljem (LU EL) / prirodni plin 2H (G20, 20 i 25 mbar)
Hot-water boiler burning oil (LTO, TOLEX) / natural gas 2H (G20, 20 and 25 mbar)

Tip / model
Type / model: EKO-CUP S3 (460 kW, 530 kW, 600 kW)
EKO-CUP V3 (800 kW, 1000 kW, 1250 kW, 1500 kW)

EKO-CUP S3, EKO-CUP V3 kotlovi za loženje prirodnim plinom 2H (G20, 20 i 25 mbar) označeni s CE-1015CQ0504:
EKO-CUP S3, EKO-CUP V3 boilers burning natural gas 2H (G20, 20 and 25 mbar) designated with CE-1015CQ0504:

odgovara zahtjevima sljedećih propisa: / *is in conformity with the provisions of the following Directives:*

Uredba Komisije / *Commission Regulation (EU) 2016/426*

Direktiva / *Directive 2014/35/EU, LVD*

Direktiva / *Directive 2014/30/EU, EMC*

i također zadovoljava zahtjeve sljedećih standardi: / *and also complies with the following standards:*

ČSN EN 15502-1+A1:2017; ČSN EN 15502-2-1+A1:2017; ČSN EN 437+A1:2009; ČSN EN 303 1:2018; ČSN EN 303-3:1999; ČSN EN 14394+A1:2009 (apl. art.); ČSN 06 1008:1997; ČSN EN 60335 1:2012 ed. 3; ČSN EN 60335-2-102:2016 ed.2; ČSN EN 55014-1:2007 ed.3; ČSN EN 61000-6-3:2007 ed.2; ČSN EN 61000-3-2:2015 ed.4; ČSN EN 61000-3-3:2014 ed. 3; ČSN EN 61000-6-2:2006 ed 3; ČSN EN 62233:2008

EKO-CUP S3, EKO-CUP V3 kotlovi za loženje ekstra lakim loživim uljem (LU EL) označeni s CE-1015CQ0505:

EKO-CUP S3, EKO-CUP V3 boilers burning oil (LTO, TOLEX) designated with CE-1015CQ0505:

odgovara zahtjevima sljedećih propisa: / *is in conformity with the provisions of the following Directives:*

Direktiva / *Directive 2014/35/EU, LVD*

Direktiva / *Directive 2014/30/EU, EMC*

i također zadovoljava zahtjeve sljedećih standardi: / *and also complies with the following standards:*

ČSN EN 303-1:2018; ČSN EN 303-2:2018; ČSN EN 14394+A1:2009 (apl. art.); ČSN 06 1008:1997; ČSN EN 60335-1:2012 ed. 3; ČSN EN 60335-2-102:2016 ed.2; ČSN EN 55014 1:2007 ed.3; ČSN EN 61000-6-3:2007 ed.2; ČSN EN 61000-3-2:2015 ed.4; ČSN EN 61000-3-3:2014 ed. 3; ČSN EN 61000-6-2:2006 ed 3; ČSN EN 62233:2008; ČSN EN 267:2012 ed.2

Godina izdavanja CE oznake
Year of affixing of CE marking

2015.

Mjesto i vrijeme izdavanja
Place and date of issue

Macinec, 22.10.2018.

Ime, prezime i potpis ovlaštene osobe
Name, surname and signature of authorized person

Davor Zidarić

Centrometal
40306 MACINEC, Glavna 12
Tel: +385 (0)40 775 800, Fax: +385 (0)40 775 811



EC IZJAVA O SUKLADNOSTI EC DECLARATION OF CONFORMITY

Proizvođač
Manufacturer: Centrometal d.o.o.
Naziv i adresa
Name and address: HR-40306 Macinec, Glavna 12, Croatia

Punom odgovornošću izjavljujemo, da
We declare under our sole responsibility that

Proizvod
Product designation: Toplovodni kotao za loženje ekstra lakim loživim uljem (LU EL) / prirodni plin 2H (G20, 20 i 25 mbar)
Hot water boiler burning oil (LTO, TOLEX) / natural gas 2H (G20, 20 and 25 mbar)
Tip / model
Type / model: EKO-CUP SV3 2500 (2100 kW)

EKO-CUP SV3 2500 kotao za loženje prirodnim plinom 2H (G20, 20 i 25 mbar) označen s CE-1015CQ0504:
EKO-CUP SV3 2500 boiler burning natural gas 2H (G20, 20 and 25 mbar) designated with CE-1015CQ0504:

odgovara zahtjevima sljedećih propisa: / is in conformity with the provisions of the following Directives:

Uredba Komisije / *Commission Regulation (EU) 2016/426*

Direktiva / *Directive 2014/35/EU, LVD*

Direktiva / *Directive 2014/30/EU, EMC*

i također zadovoljava zahtjeve sljedećih standardi: / and also complies with the following standards:

ČSN EN 15502-1+A1:2017; ČSN EN 15502-2-1+A1:2017; ČSN EN 437+A1:2009; ČSN EN 303-1:2018; ČSN EN 303-3:1999; ČSN EN 14394+A1:2009 (apl. art.); ČSN 06 1008:1997; ČSN EN 60335-1:2012 ed. 3; ČSN EN 60335-2-102:2016 ed.2; ČSN EN 55014-1:2007 ed.3; ČSN EN 61000-6-3:2007 ed.2; ČSN EN 61000-3-2:2015 ed.4; ČSN EN 61000-3-3:2014 ed. 3; ČSN EN 61000-6-2:2006 ed 3; ČSN EN 62233:2008

EKO-CUP SV3 2500 kotao za loženje ekstra lakim loživim uljem (LU EL) označen s CE-1015CQ0505:

EKO-CUP SV3 2500 boiler burning oil (LTO, TOLEX) designated with CE-1015CQ0505:

odgovara zahtjevima sljedećih propisa: / is in conformity with the provisions of the following Directives:

Direktiva / *Directive 2014/35/EU, LVD*

Direktiva / *Directive 2014/30/EU, EMC*

i također zadovoljava zahtjeve sljedećih standardi: / and also complies with the following standards:

ČSN EN 303-1:2018; ČSN EN 303 2:2018; ČSN EN 14394+A1:2009 (apl. art.); ČSN 06 1008:1997; ČSN EN 60335-1:2012 ed. 3; ČSN EN 60335-2-102:2016 ed.2; ČSN EN 55014-1:2007 ed.3; ČSN EN 61000-6-3:2007 ed.2; ČSN EN 61000-3-2:2015 ed.4; ČSN EN 61000-3-3:2014 ed. 3; ČSN EN 61000-6-2:2006 ed 3; ČSN EN 62233:2008; ČSN EN 267:2012 ed.2

Godina izdavanja CE oznake
Year of affixing of CE marking

2019.

Mjesto i vrijeme izdavanja
Place and date of issue

Macinec, 22.10.2019.

Ime, prezime i potpis ovlaštene osobe
Name, surname and signature of authorized person

Davor Zidarić

Centrometal
40306 MACINEC, Croatia
Centrometal GMBH 872-800, Fax: 072-611

WiFi
READY



Centrometal d.o.o. assumes no responsibility for possible inaccuracies in this book originated typographical errors or rewriting, all figures and diagrams are principal and it is necessary to adjust each actual situation on the field, in any case the company reserves the right to enter their own products such modifications as considered necessary.

Centrometal d.o.o. Glavna 12, 40306 Macinec, Croatia

central tel: +385 40 372 600, fax: +385 40 372 611
service tel: +385 40 372 622, fax: +385 40 372 621

www.centrometal.hr
e-mail: servis@centrometal.hr

Centrometal
HEATING TECHNIQUE